



vuma[®]
Revolution-air hand dryer



CATALOGO **2023**

2023





VAMA® sviluppa prodotti sostenibili e ad alto valore aggiunto. Lavoriamo per offrire agli utenti soluzioni innovative ed efficienti, che minimizzano l'impatto ambientale delle attività umane, con prodotti affidabili e sicuri, che promuovono igiene e comfort.



VAMA® develops sustainable value-added products. We're on a never-ending mission to improve the user experience with low-waste and low-energy solution, with reliable, safe products that promote hygiene and comfort.



VAMA® développe des produits durables à haute valeur ajoutée. Nous travaillons pour offrir aux utilisateurs des solutions innovantes et efficaces qui minimisent l'impact environnemental des activités humaines, avec des produits fiables et sûrs qui favorisent l'hygiène et le confort.



🇮🇹 Produzione a brand proprio e private label in 40 paesi del mondo

🇬🇧 OEM and private label production

MADE IN ITALY



🇮🇹 **50 Kw** di pannelli fotovoltaici per autoproduzione e riscaldamento

🇬🇧 **100 %** use of renewable energy with 50 Kw solar panels



**DESIGN
ECOSOSTENIBILE**





loading ...







 Gli asciugamani Eco-Jet VAMA[®] sono realizzati con un'innovativa tecnologia di riciclo, che permette di rigenerare gli scarti plastici derivanti dalla produzione, scegliendo solo materiali di prima scelta. Riduciamo così il nostro impatto ambientale partendo dalla creazione stessa del prodotto.

 VAMA[®] Eco-Jet hand dryers are manufactured through an advanced form of recycling that allows to regenerate plastic waste. We reduce our environmental impact starting from the product itself.

 Les sèche-mains VAMA[®] Eco-jet sont fabriqués grâce à une forme avancée de recyclage qui permet de régénérer les déchets plastiques. Nous réduisons notre impact environnemental à partir du produit lui-même.





 Gli asciugamani Eco-Jet VAMA[®] riducono l'impatto ambientale abbattendo le emissioni di CO2 rispetto all'utilizzo di carta monouso o di asciugamani tradizionali.

 VAMA[®] Eco-Jet Hand Dryers extremely reduce carbon footprint and CO2 emissions comparing to paper or cotton use.

 Les sèche-mains VAMA[®] Eco-jet réduisent l'impact environnemental en réduisant les émissions de CO2 par rapport à l'utilisation de papier jetable ou de sèche-mains traditionnelles.





 Gli asciugamani Eco-Jet VAMA[®] contrastano la deforestazione e non generano rifiuti come la carta monouso. Inoltre, una volta giunti a fine vita, sono riciclabili e VAMA[®] ne assicura il corretto riciclo qualora l'utente finale ne richieda il ritiro.

 VAMA[®] Eco-Jet Hand Dryers are recyclable, they reduce waste and deforestation compared to disposable paper. At the end of their life cycle, if the end user requests their collection, VAMA ensures their correct recycling.



 Les sèche-mains VAMA[®] Eco-jet combattent la déforestation, ils ne génèrent pas de déchets tels que le papier jetable. De plus, une fois arrivés en fin de vie, ils sont recyclables et VAMA s'assure de leur bon recyclage en cas de demande de collecte par l'utilisateur final.

Our dedication to Sustainability





-  Gli asciugamani Eco-Jet VAMA® utilizzano l'80/90% in meno di elettricità rispetto ai modelli tradizionali.
-  VAMA® Eco-Jet Hand Dryers use 80/90% less energy compared to traditional hand dryers.
-  Les sèche-mains VAMA® Eco-jet consomment 80/90% de moins que les sèche-mains traditionnelles.



-  I nostri prodotti sono completamente fabbricati grazie all'energia autoprodotta dal nostro impianto fotovoltaico da 50 Kw, senza utilizzo di fonti energetiche fossili
-  Our products are completely manufactured thanks to the self-produced energy from our 50 Kw photovoltaic system, without the use of fossil energy sources
-  Nos produits sont entièrement fabriqués grâce à l'énergie autoproduite par notre système photovoltaïque de 50 Kw, sans l'utilisation de sources d'énergie fossiles



-  Filiera a km 0, dallo stampaggio del polimero e dell'acciaio fino al prodotto finito
-  0 km supply chain, from the molding of polymer and steel to the finished product
-  Chaîne d'approvisionnement de 0 km, du moulage du polymère et de l'acier au produit fini

HYGIENE

WASHROOMS
PUBLIC WASH WASHROOMS
PERSONAL TOUCHLESS
HEPA
HAND HYGIENE
SANITATION
SANITIZE
STOP FAKE NEWS UVC
TREATMENT UVC
RESTROOMS
CLEANING
WASHING CLEAN
HEPATIC
AUTOMATIC
CONTACTLESS
STANDARD WASH
CLEANLINESS
BODY
HEALTH
STOP FAKE NEWS

Upgrade to AIR-filtered hand dryers

HEPA-EPA FILTER

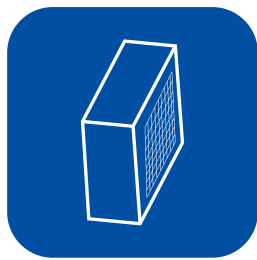

UV-C DISINFECTION TECHNOLOGY



EASY CLEANING & MAINTENANCE



Asciugamani

Eco-jet

Hand dryers
Sèche-mains



Dry Max UV.....	14	Stream dry UV	39
Xdry Compact.....	21	Eco Stream / Eco Flow	45
Xdry	27	Smart Jet	53
Tornado Protech.....	33	Laser Flow	57
		Vision Air	64

ASCIUGAMANI TRADIZIONALI IN ACCIAIO

STAINLESS STEEL HAND DRYERS - SÈCHE-MAINS EN ACIER



Ariel	71
-------------	----

ASCIUGAMANI TRADIZIONALI IN ABS

ABS HAND DRYERS - SÈCHE-MAINS EN ABS



Unik	75	AEA - Turbotime - Turbotronic	78
------------	----	-------------------------------------	----

Asciugacapelli

Linea Hotel

Hotel Hair dryers
Sèche-cheveux - Ligne hotel



Comfort Pro	82	Eternity	92
Viento Space	84	Fit Phon	94
Elegant Pro	86	Tiny	96
Viento	88	Atelier Shaver	97
Pro phon	91		



Minibar	98	Bollitore.....	107
Casseforti	104	Accessori linea Hotel.....	108

Sport Hair dryers
Sèche-cheveux pour le sport

Asciugacapelli

Linea Sport



Fit Phon 1000 W	116	Unik Hair - Acea	122
Pro Phon 1800 W	116	Turbo 3	124
Stream Dry Hair	117	Gettoniere	125
Ariel Hair	120	Aspiratori	127

Washroom Equipments
Equipements Sanitaires

Linea Igiene



Linea dispenser INOX	130	Gettacarte	133
Portascopino INOX	132	Maniglioni murali	134
Pattumiere a pedale	132	Linea dispenser ABS	135
		Linea Anticovid	137



ASCIUGAMANI ELETTRICI



Hand Dryers - Sèche-mains

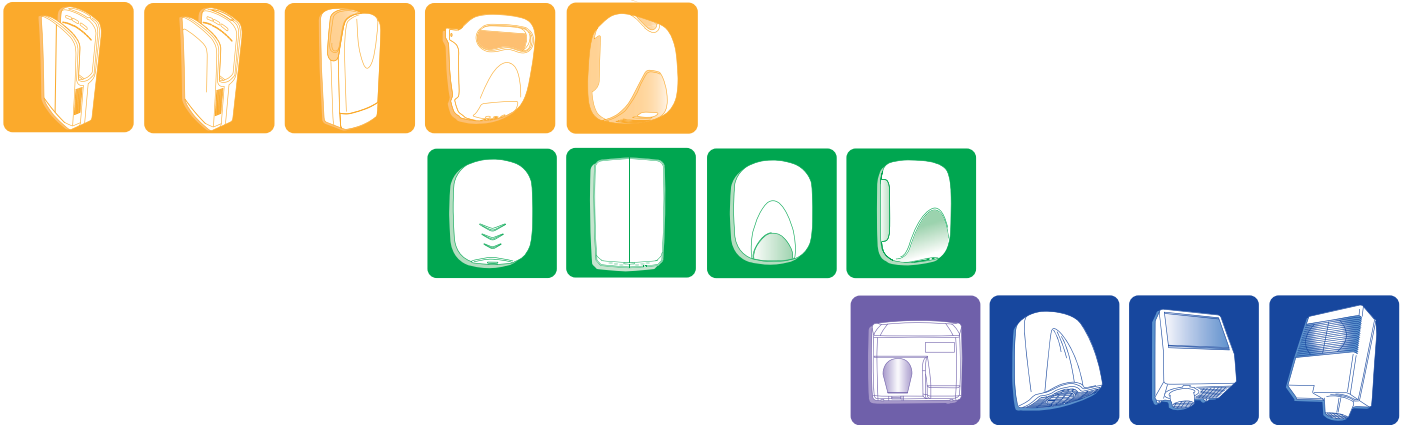

Asciugamani - Hand dryers - Sèche-mains

Guida veloce alla scelta / Hand dryers quick guide / Guide rapide pour sèche-mains



-  VAMA® offre una GAMMA COMPLETA di asciugamani elettrici ECO-JET ad elevata efficienza energetica, sviluppati per garantire igiene, sicurezza e sostenibilità ambientale. Proponiamo 3 gamme di asciugamani, suddivisi in 13 famiglie, disponibili in una grande varietà di finiture e opzioni.
-  VAMA® provides an EXTENSIVE RANGE of high-speed energy efficient hand dryers (ECO-JET), developed to guarantee hygiene, safety and sustainability. We manufacture and commercialize 3 kind of hand dryers, divided into 13 families, available with different features and finishing.
-  VAMA® propose une GAMME COMPLÈTE de sèche-mains électriques ECO-JET à haute efficacité énergétique, développés pour garantir hygiène, sécurité et durabilité environnementale. Nous vous proposons 3 gammes de sèche-mains, réparties en 13 familles, disponibles dans une grande variété de finitions et d'options.



COME SCEGLIERE / HOW TO CHOOSE / COMME CHOISIR?

ECO-JET



CONVENTIONAL



PREMIUM

XDry
COMPACT



TORNADO
Rotech



VISIONair



XDry
pro



HIGH TRAFFIC

Stream
dry
UV



drymax^{uv}



LASER
FLOW



ECO
Stream



ECO
Flow

ARIEL



ENTRY LEVEL

smart jet
mini



U-nik



AEA



TURBOTRONIC





DRY MAX UV

ECO-JET DRYERS

ASCIUGAMANI - HAND DRYERS - SÈCHE-MAINS

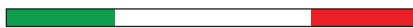

MADE IN ITALY



191 - 300 Km/h



225 - 1000 W



Anti-covid
tested filter



 **VELOCITÀ ed EFFICACIA**
Tempo di asciugatura super veloce in 15 sec.



 **ULTRA - FAST DRYING TIME**
High speed hand dryer, drying time 15 sec.

 **RAPIDITÉ ET EFFICACITÉ**
Temps de séchage ultra rapide en 15 secondes

 **EFFICIENZA ENERGETICA**
Massimo risparmio energetico, consumi variabili da 225 W a 1000 W *



* 225 W con resistenza spenta e variatore al minimo - 1000 W con resistenza accesa e variatore al massimo

 **ENERGY EFFICIENCY**
Energy efficient hand dryer, rated power minimum 225 W - maximum 1000 W *

* 225 W heating element OFF and variator minimum level - 1000 W heating element ON and variator maximum level

 **EFFICACITÉ ÉNERGÉTIQUE**
Économie d'énergie maximale, consommation variable de 225 W à 1000 W *

* 225 W avec résistance désactivée et variateur au minimum - 1000 W avec résistance activée et variateur au maximum

 **IGIENE e SICUREZZA**
Igiene garantita dalla filtrazione dell'aria e dalla sanificazione dei componenti interni



 **HYGIENE and SAFETY**
Engineered for hygienic performance, air flow filtering and UV-C disinfection (24/7)

 **HYGIÈNE ET SÉCURITÉ**
Hygiène garantie par la filtration de l'air et la désinfection des composants internes

 **COMFORT e SILENZIOSITÀ**
Variatore per la regolazione della potenza e della rumorosità



 **NOISELESS**
Adjustable energy consumption, noise level and drying time

 **CONFORT**
Variateur pour la régulation de la puissance et du bruit

 **DESIGN COMPATTO ED ELEGANTE**
Minimo ingombro, profondità inferiore a 10 cm.

 **STYLISH AND COMPACT DESIGN**
Very compact in size, depth less than 10 cm.

 **DESIGN COMPACT ET ÉLÉGANT**
Taille très compacte, profondeur inférieure à 10 cm.

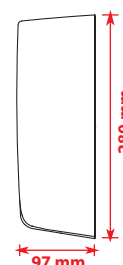

ARTICOLI & CODICI PRODOTTI

MODEL REFERENCE CHART

TABLEAU DES MODÈLE DE RÉFÉRENCE

Cod.

DRY MAX UV BF	ABS bianco / white ABS / ABS blanc
DRY MAX UV SF	ABS satinato / satin ABS / ABS satiné
DRY MAX UV LF	ABS lucido / chromed ABS / ABS brillant
DRY MAX UV NF	ABS nero / black ABS / ABS noir



- FILTRO EPA E11**
Filtro con efficacia antivirale / antibatterica incluso
- EPA FILTER E11**
Antiviral and antibacterial filter included
- FILTRE EPA E11**
Filtre efficacement antiviral / antibactérien

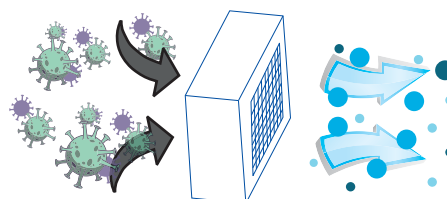

- LAMPADA UVC**
per disinfezione del condotto di ventilazione
- UVC LAMP**
for internal parts disinfection
- LAMPADE UVC**
pour disinfection de la chambre d-air



- RESISTENZA ON-OFF**
- HEATING ON-OFF**
- CHAUFFAGE ON-OFF**

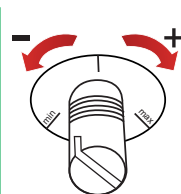

- VARIATORE**
per regolazione di potenza e rumorosità
- VARIABLE SPEED**
adjustable energy consumption, noise level and drying time
- VARIATEUR**
pour réguler la puissance et le bruit du moteur

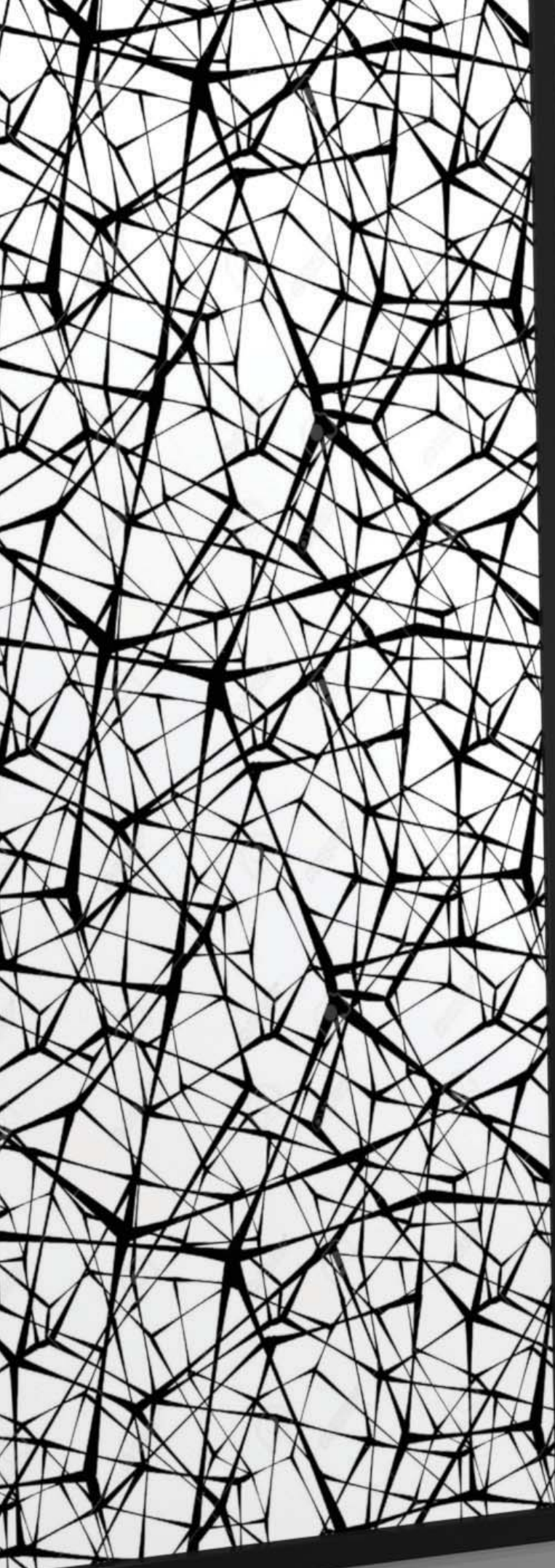



ASCIUGAMANI - HAND DRYERS - SÈCHE-MAINS

- CONFRONTO COSTI DI ASCIUGATURA ANNUALI
- ANNUAL SAVINGS CALCULATIONS
- CALCULEZ VOS COÛTS/ECONOMIES ANNUELLES

N° UTILIZZI GIORNALIERI DAILY USE UTILISATION PAR JOUR	 1000 W	CARTA PAPER PAPIER	COTONE COTTON COTON	 2400 W
100	€ 43,22/anno	€ 876,00	€ 744,60	€ 250,35
200	€ 86,43/anno	€ 1.752,00	€ 1.489,20	€ 500,71
400	€ 172,87/anno	€ 3.504,00	€ 2.978,40	€ 1.001,41



Calcoli basati su 365 giorni/anno. Costo dell'energia 0,361 €/kWh. Costo salvietta di carta monouso € 0,008, con una media di 3 salviette per asciugatura. Costo asciugatura con rotolo di cotone € 0,0204 (escluso canone dispenser).



Counts are based on 365 days per year. Energy cost 0,361 €/kWh. The average cost of a paper towel is € 0,008 (3 paper towel sheets per user). The average cost of a cotton towel is € 0,0204 (dispenser fee excluded).



Calculs basés sur 365 jours/an. Coût énergétique de 0,361 €/kWh. Les serviettes en papier jetables coûtent € 0,008 avec une moyenne de 3 lingettes par séchage. Coût du serviettes en coton de € 0,0204 (frais de location du distributeur exclus).

CARATTERISTICHE TECNICHE / TECHNICAL FEATURES / CARACTÉRISTIQUES TECHNIQUES

Funzionamento	Sensore di rilevam. elettronico a raggi infrarossi
Functioning	Sensor operating
Activation	Capteur électronique
Giri al minuto	
Tr min	12.000 - 24.000 rpm
Révolutions par minute	
Grado di protezione elettrica	
Electrical Protection Level	IP33 - CLASS II
Isolation électrique	
Tensione	
Supply Voltage	220 V-240 V
Tension d'alimentation	
Potenza totale	
Total power	225 - 1000 W
Puissance totale	
Potenza resistenza	
Absorption Heating Element	0 - 500 W (ON-OFF)
Puissance chauffage	
Potenza motore	
Absorption Motor	225 - 500 W
Puissance moteur	
Dimensioni A x L x P	
Dimensions H x W x D	280 X 180 X 97 mm
Dimensions H x L x P	
Frequenza	
Frequency	50-60 Hz
Fréquence	
Velocità aria	
Air Speed	191 - 300 km/h
Vitesse d'air	

Volume aria	
Air flow	max 120 mc/h
Débit d'air	
Peso	
Weight	1,86 Kg
Poids net	
Materiale	
Materials	ABS
Matériel	
Marchi di qualità	
Quality marks - certifications	CE - ROHS
Certification	
Rumorosità (2m)	
Noise level (2m)	68 - 75 db
Niveau sonore (2m)	
Garanzia	3 anni
Warranty	3 years
Garantie	3 ans

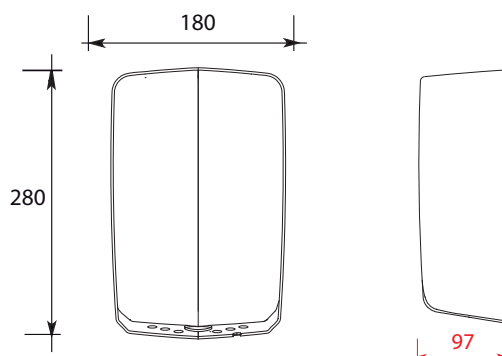

Per le limitazioni di garanzia si vedano le condizioni generali di servizio

Limited warranty. Please have a look to the General Warranty Conditions for details and consumable

Limitations de garantie: revoir Conditions de Garantie Generale

Xdry COMPACT



VELOCITÀ ASCIUGATURA
DRYING TIME / TEMPS DE SÉCHAGE



RISPARMIO ENERGETICO
ENERGY SAVING / ÉPARGNE ENERGETIQUE



SILENZIOSITÀ
NOISELESS / SILENCIEUX



DESIGN



ANTIVANDALISMO
ANTIVANDALISM / ANTIVANDALISME



X DRY COMPACT

ASCIUGAMANI - HAND DRYERS - SÈCHE-MAINS

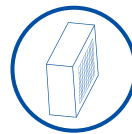

 **VELOCITÀ ed EFFICACIA**
Tempo di asciugatura super veloce in 12 / 15 sec.



 **ULTRA - FAST DRYING TIME**
High speed hand dryer, drying time 12 / 15 sec.

 **RAPIDITÉ ET EFFICACITÉ**
Temps de séchage ultra rapide en 12 / 15 secondes

 **EFFICIENZA ENERGETICA**
Massimo risparmio energetico, solo 1100 W*
* 1100 W con resistenza spenta - 1450 W con resistenza accesa



 **ENERGY EFFICIENCY**
Energy efficient hand dryer, rated power 1100 W*
* 1100 heating element OFF - 1450 W with heating element ON

 **EFFICACITÉ ÉNERGÉTIQUE**
Économie d'énergie maximale, consommation 1100 W*
* 1100 W avec résistance désactivée et variateur au minimum -1450 W avec résistance activée

 **IGIENE e SICUREZZA**
Igiene garantita dalla filtrazione dell'aria e dalla sanificazione dei componenti interni



 **HYGIENE and SAFETY**
Engineered for hygienic performance, air flow filtering and UV-C disinfection (24/7)

 **HYGIÈNE ET SÉCURITÉ**
Hygiène garantie par la filtration de l'air et la désinfection des composants internes

 **COMFORT**
Acustica perfezionata, nuova progettazione del motore e dei flussi d'aria



 **COMFORT**
Quiet operation, new motor technology and re-engineered airflows

 **CONFORT**
Fonctionnement silencieux, nouvelle technologie moteur et débits d'air renouvelés

 **DESIGN COMPATTO ED ELEGANTE**
Minimo ingombro

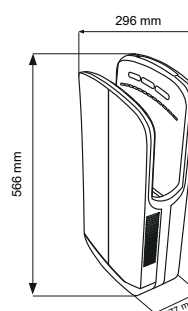

 **STYLISH AND COMPACT DESIGN**
Designed for compact spaces

 **DESIGN COMPACT ET ÉLÉGANT**
Taille compacte



X DRY COMPACT

ASCIUGAMANI - HAND DRYERS - SÈCHE-MAINS

-  **ARTICOLI & CODICI PRODOTTI**
-  **MODEL REFERENCE CHART**
-  **TABLEAU DES MODÈLE DE RÉFÉRENCE**





Cod.

X DRY COMPACT BF	ABS bianco/white/blanc	Brush
X DRY COMPACT SF	ABS grigio/grey/gris	Brush
X DRY COMPACT NF	ABS nero/black/noir	Brush



 Il design ergonomico consente l'inserimento delle mani in maniera naturale. Un doppio getto di aria pulita a oltre 410 km/h avvolge le mani su entrambi i lati, consentendo un'asciugatura perfetta e l'eliminazione della sensazione di umidità, in soli 12 - 15 secondi

 Ergonomic design creates a comfortable user experience. 410 km/h double jet air flow on both sides moves water from hands in 12 - 15 seconds

 La conception ergonomique permet l'insertion des mains d'une manière naturelle. Un double jet d'air pulsé à 410 km/h entre les mains deux côtes permet un séchage parfait et élimine la sensation d'humidité, en 12 - 15 secondes.



Tasto ON-OFF per la Resistenza elettrica

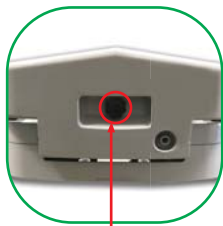

 Blocco di sicurezza per la vaschetta di raccolta dell'acqua

 Safety lock for water tank

 Verrou de sécurité pour le réservoir de récupération d'eau





 Vaschetta per la raccolta dell'acqua, al di sotto si trova il tasto ON-OFF per la gestione della resistenza elettrica

 Water tank, on-off heating element button is located below

 Reservoir de collecte d'eau, ci-dessous bouton ON-OFF pour la gestion de la résistance



 Doppio filtro EPA E11 garantisce protezione contro il 97,66% di virus e batteri

 Inbuilt double antiviral / antibacterial filters as standard equipment. They allow protection against 97,66% of viruses and bacteria

 Double filtre antibactérien / antiviral inclus. Assure une protection contre 97,66% des virus et bactéries



 Doppia lampada UV-C per la disinfezione del blocco motore

 Double UV-C lamp for internal parts disinfection

 Double lampe UV-C pour désinfection du bloc moteur

- CONFRONTO COSTI DI ASCIUGATURA ANNUALI
- ANNUAL SAVINGS CALCULATION
- CALCULEZ VOS COÛTS/ECONOMIES ANNUELLES

N° UTILIZZI GIORNALIERI DAILY USE UTILISATION PAR JOUR	 1450 W	CARTA PAPER PAPIER	COTONE COTTON COTON	 2400 W
100	€ 56,26 / anno	€ 876,00	€ 744,60	€ 250,35
200	€ 112,52 / anno	€ 1.752,00	€ 1.489,20	€ 500,71
400	€ 225,05 / anno	€ 3.504,00	€ 2.978,40	€ 1.001,41



Calcoli basati su 365 giorni/anno. Costo dell'energia 0,361 €/kWh. Costo salvietta di carta monouso € 0,008, con una media di 3 salviette per asciugatura. Costo asciugatura con rotolo di cotone € 0,0204 (escluso canone dispenser).



Counts are based on 365 days per year. Energy cost 0,361 €/kWh. The average cost of a paper towel is € 0,008 (3 paper towel sheets per user). The average cost of a cotton towel is € 0,0204 (dispenser fee excluded).



Calculs basés sur 365 jours/an. Coût énergétique de 0,361 €/kWh. Les serviettes en papier jetables coûtent € 0,008 avec une moyenne de 3 lingettes par séchage. Coût du serviettes en coton de € 0,0204 (frais de location du distributeur exclus).

CARATTERISTICHE TECNICHE / TECHNICAL FEATURES / CARACTÉRISTIQUES TECHNIQUES

Funzionamento	Automatico	Dimensioni A x L x P	
Functioning	Automatic	Dimensions H x W x D	566 x 296 x 177 mm
Activation	Automatique	Dimensions H x L x P	
Giri al minuto		Frequenza	
Tr min	28000 rpm	Frequency	50-60 Hz
Révolutions par minute		Fréquence	
Grado di protezione elettrica		Velocità aria	
Electrical Protection Level	IP34 - CLASS II	Air Speed	410 km/h
Isolation électrique		Vitesse d'air	
Tensione		Volume aria	
Supply Voltage	220 V-240 V	Air Flow	187 m ³ /h
Tension d'alimentation		Débit d'air	
Potenza totale		Peso	
Total power	1450 W	Weight	6,56 Kg
Puissance totale		Poids net	
Potenza resistenza		Materiale	
Absorption Heating Element	350 W	Materials	ABS
Puissance chauffage		Matériel	
Potenza motore		Rumorosità (2 mt)	
Absorption Motor	1100 W	Noise Level (2 mt)	73 dB
Puissance moteur		Ni eau de bruit (2 mt)	

ALTEZZA DI INSTALLAZIONE DA TERRA
PUNTO DI INSERIMENTO DELLE MANI
INSTALLATION HEIGHT FROM FLOOR
POINT OF ENTRY OF HANDS
HAUTEUR D'INSTALLATION DE PLANCHER
POINT D'ENTRÉE DES MAINS



**MINIMO INGOMBRO
COMPACT SIZE
TAILLE COMPACTE**

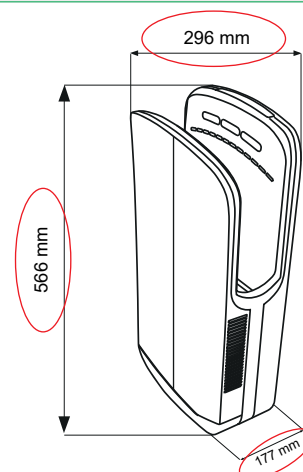

* Per le limitazioni di garanzia si vedano le condizioni generali di servizio

* Limited warranty. Please have a look to the General Warranty Conditions for details and consumables

* Limitations de garantie: revoir Conditions de Garantie Generale





VELOCITÀ ASCIUGATURA
DRYING TIME / TEMPS DE SÉCHAGE



RISPARMIO ENERGETICO
ENERGY SAVING / ÉPARGNE ENERGETIQUE



SILENZIOSITÀ
NOISELESS / SILENCIEUX



DESIGN



ANTIVANDALISMO
ANTIVANDALISM / ANTIVANDALISME



X DRY - X DRY PRO

ASCIUGAMANI - HAND DRYERS - SÈCHE-MAINS

XDry - XDry pro

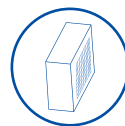



- Asciugamani elettrico ECO-JET

- Dimensioni compatte, minimo ingombro

- Velocità aria 410 km/h

- Asciugatura super-veloce in 12/15 sec.

- Disponibile sia con motore standard TOP-AC (X Dry) che con motore digitale brushless (X Dry Pro)

- Resistenza elettrica regolabile ON-OFF per la massima efficienza energetica

- LED per il monitoraggio del ciclo di asciugatura

- **Sonda sulla resistenza elettrica**, spegnimento automatico al raggiungimento di una temperatura del flusso d'aria pari a 30 °C



- ECO-JET hand dryer

- Compact size, it takes up in a minimal amount of space

- Air speed 410 km/h

- Fastest drying time, 12/15 sec.

- Available with TOP-AC motor (X Dry) or with brushless motor (X Dry Pro)

- Adjustable heating element (ON-OFF)

- Luminous LED for quick check of the drying cycle

- **Probe on the heating element**, automatic shut-off when the airflow temperature reaches 30 °C



- Seche mains ECO-JET

- Taille compacte, encombrement minimal

- Vitesse d'air 410 km/h

- Séchage ultra-rapide en 12/15 sec.

- Disponible à la fois avec moteur TOP-AC (X Dry) standard et avec moteur brushless numérique (X Dry Pro)

- Résistance électrique ON-OFF réglable pour une efficacité énergétique maximale

- Lumineux à LED pour un contrôle rapide du cycle de séchage

- **Sonde sur la résistance électrique**, arrêt automatique lorsque la température de départ de l'air est de 30° C



Sonda sulla resistenza elettrica, spegnimento automatico al raggiungimento di una temperatura del flusso d'aria pari a 30°



Probe on the heating element, automatic shut-off when the airflow temperature reaches 30° C



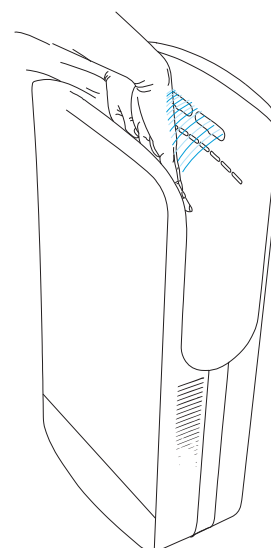

Sonde sur la résistance électrique, arrêt automatique lorsque la température de départ de l'air est de 30° C



X DRY - X DRY PRO

ASCIUGAMANI - HAND DRYERS - SÈCHE-MAINS

-  **ARTICOLI & CODICI PRODOTTI**
-  **MODEL REFERENCE CHART**
-  **TABLEAU DES MODÈLE DE RÉFÉRENCE**





Cod.

X DRY BF	ABS bianco/white/blanc	Top AC
X DRY SF	ABS grigio/grey/gris	Top AC
X DRY PRO BF	ABS bianco/white/blanc	Brushless
X DRY PRO SF	ABS grigio/grey/gris	Brushless

-  **FILTRO EPA INCLUSO**
-  **EPA FILTER INCLUDED**
-  **FILTRE EPA INCLUS**





 Il design economico consente l'inserimento delle mani in maniera naturale. Un doppio getto di aria pulita a oltre 410 km/h avvolge le mani su entrambi i lati, consentendo un'asciugatura perfetta e l'eliminazione della sensazione di umidità, in soli 12 - 15 secondi

 Natural and ergonomic designer for easy access. 410 km/h double jet air flow on both sides moves water from hands in 12 - 15 seconds

 La conception ergonomique permet l'insertion des mains d'une manière naturelle. Un double jet d'air pulsé à 410 km/h entre les mains deux côtes permet un séchage parfait et élimine la sensation d'humidité, en 12 - 15 secondes.



 Il motore brushless (1200 W) garantisce totale assenza di residui di carbone nel flusso d'aria; il motore TOP-AC (1250 W) il miglior prezzo

 Brushless motor (1200 W) allows 100% carbon free airflow; TOP-AC motor (1200 W) the best price

 Moteur brushless (1200 W) garantit l'absence totale de résidus de carbone dans le flux d'air; moteur TOP-AC (1250W) le meilleur prix



Tasto ON-OFF per resistenza elettrica

 Vaschetta per la raccolta dell'acqua, al di sotto si trova il tasto ON-OFF per la gestione della resistenza elettrica

 Water tank, the on-off heating element button is located below

 Reservoir de collecte d'eau, ci-dessous bouton ON-OFF pour la gestion de la résistance



 Doppio filtro EPA E11 garantisce protezione contro il 97,66% di virus e batteri

 Inbuilt double antiviral / antibacterial filters as standard equipment. They allow protection against 97,66% of viruses and bacteria

 Double filtre antibactérien / antiviral inclus. Assure une protection contre 97,66% des virus et bactéries

CONFRONTO COSTI DI ASCIUGATURA ANNUALI

ANNUAL SAVINGS CALCULATION

CALCULEZ VOS COÛTS/ECONOMIES ANNUELLES

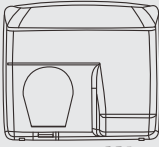
N° UTILIZZI GIORNALIERI DAILY USE UTILISATION PAR JOUR	X Dry pro 1750 W	CARTA PAPER PAPIEL	COTONE COTTON COTON	 2400 W
100	€ 64,30 / anno	€ 876,00	€ 744,60	€ 250,35
200	€ 128,60 / anno	€ 1.752,00	€ 1.489,20	€ 500,71
400	€ 257,20 / anno	€ 3.504,00	€ 2.978,40	€ 1.001,41



Calcoli basati su 365 giorni/anno. Costo dell'energia 0,361 €/kWh. Costo salvietta di carta monouso € 0,008, con una media di 3 salviette per asciugatura. Costo asciugatura con rotolo di cotone € 0,0204 (escluso canone dispenser).



Counts are based on 365 days per year. Energy cost 0,361 €/kWh. The average cost of a paper towel is € 0,008 (3 paper towel sheets per user). The average cost of a cotton towel is € 0,0204 (dispenser fee excluded).



Calculs basés sur 365 jours/an. Coût énergétique de 0,361 €/kWh. Les serviettes en papier jetables coûtent € 0,008 avec une moyenne de 3 lingettes par séchage. Coût du serviettes en coton de € 0,0204 (frais de location du distributeur exclus).

CARATTERISTICHE TECNICHE / TECHNICAL FEATURES / CARACTÉRISTIQUES TECHNIQUES

Funzionamento	Automatico	Dimensioni A x L x P	
Functioning	Automatic	Dimensions H x W x D	565 x 298 x 170 (mm)
Activation	Automatique	Dimensions H x L x P	
Giri al minuto		Frequenza	
Tr min	28000 rpm	Frequency	50-60 Hz
Révolutions par minute		Fréquence	
Grado di protezione elettrica		Velocità aria	
Electrical Protection Level	IP31 - CLASS I	Air Speed	410 km/h
Isolation électrique		Vitesse d'air	
Tensione		Volume aria	
Supply Voltage	220 V-240 V	Air Flow	187 m ³ /h
Tension d'alimentation		Débit d'air	
Potenza totale		Peso	
Total power	1700 W AC Motor / 1750 W Brushless	Weight	7,2 Kg
Puissance totale		Poids net	
Potenza resistenza		Materiale	
Absorption Heating Element	450 W AC Motor / 650 W Brushless	Materials	ABS
Puissance chauffage		Matériel	
Potenza motore		Rumorosità (2 mt)	
Absorption Motor	1250 W AC Motor / 1100 W Brushless	Noise Level (2 mt)	75 dB
Puissance moteur		Niveau de bruit (2 mt)	

ALTEZZA DI INSTALLAZIONE DA TERRA

PUNTO DI INSERIMENTO DELLE MANI

INSTALLATION HEIGHT FROM FLOOR

POINT OF ENTRY OF HANDS

HAUTEUR D'INSTALLATION DE PLANCHER

POINT D'ENTRÉE DES MAINS



100 cm 95 cm 85 cm



* Per le limitazioni di garanzia si vedano le condizioni generali di servizio

* Limited warranty. Please have a look to the General Warranty Conditions for details and consumables

* Limitations de garantie: revoir Conditions de Garantie Generale





VELOCITÀ ASCIUGATURA
DRYING TIME / TEMPS DE SÉCHAGE



RISPARMIO ENERGETICO
ENERGY SAVING / ÉPARGNE ENERGETIQUE



SILENZIOSITÀ
NOISELESS / SILENCIEUX



DESIGN



ANTIVANDALISMO
ANTIVANDALISM / ANTIVANDALISME



TORNADO PROTECH

ASCIUGAMANI - HAND DRYERS - SECHÈ MAINS



 **VELOCITÀ ed EFFICACIA**
Tempo di asciugatura super veloce in 12 / 15 sec.



 **ULTRA - FAST DRYING TIME**
High speed hand dryer, drying time 12 / 15 sec.

 **RAPIDITÉ ET EFFICACITÉ**
Temps de séchage ultra rapide en 12 / 15 secondes

 **EFFICIENZA ENERGETICA**
Assenza di resistenza elettrica, riscaldamento dell'aria per compressione ed attraverso il calore dei motori



 **ENERGY EFFICIENCY**
No heating element: air heating through compression and engines warming

 **EFFICACITÉ ÉNERGÉTIQUE**
Absence de résistance électrique: chauffage de l'air grâce à la compression et à la chaleur des moteurs

 **IGIENE e SICUREZZA**
No touch: azionamento automatico all'inserimento delle mani
Vaschetta di raccolta d'acqua: nessun gocciolamento sui pavimenti
Filtro EPA E11 in opzione



 **HYGIENE and SAFETY**
Touchless sensor operation
Inbuilt water tank prevents wet floor hazards
EPA E11 filter in option

 **HYGIÈNE ET SÉCURITÉ**
Système de contrôle intelligent "sans contact"
Reservoir de collecte d'eau, prévient les risques de sol mouillé
Filtre EPA E11 en option



TORNADO PROTECH



ECO-JET DRYERS

ASCIUGAMANI - HAND DRYERS - SÈCHE-MAINS

-  **ARTICOLI & CODICI PRODOTTO**
-  **MODEL REFERENCE CHART**
-  **TABLEAU DES MODÈLE DE RÉFÉRENCE**





Cod.	
TORNADO PROtech BF	ABS Bianco / White / Blanc
TORNADO PROtech SF	ABS grigio / grey / gris

-  **OPZIONE FILTRO EPA E11 (TUTTI I MODELLI)**
-  **EPA E11 FILTER OPTION (ALL MODELS)**
-  **FILTRE EPA E11 EN OPTION (TOUS LES MODÈLES)**



 Le bocche a lama d'aria consentono il massimo dell'efficacia di asciugatura attraverso un gradevole massaggio

 A double compressed air flow on both sides gives hands a pleasant massage and perfect drying effect

 Les prises d'air permettent au flux d'air de sécher avec une efficacité maximale grâce à un petit massage



L'acqua viene canalizzata nella vaschetta di raccolta alla base dell'apparecchio, evitando il gocciolamento a terra e consentendo il massimo dell'igiene e della sicurezza

The water tank avoids dripping on floors, pollution and bad smells. Ready and fast to empty and clean, it is warranty of maximum hygiene

L'eau est canalisée dans le bac de collecte à la base de l'appareil, en évitant les gouttes sur le sol, donnant une meilleure hygiène et une sécurité maximale



Il filtro EPA E11 garantisce protezione contro il 97,66% di virus e batteri presenti nell'aria che viene utilizzata durante l'asciugatura (opzione)



EPA E11 filter allows protection against 97,66% of viruses and bacteria spreading clean air on hands (option)



Le filtre EPA E11 assure une protection de 97,66% contre les virus et bactéries contenues dans l'air au cours du séchage (option)



ASCIUGAMANI- HAND DRYERS - SÈCHE-MAINS

- CONFRONTO COSTI DI ASCIUGATURA ANNUALI
- ANNUAL SAVINGS CALCULATION
- CALCULEZ VOS COÛTS/ECONOMIES ANNUELLES

N° UTILIZZI GIORNALIERI DAILY USE UTILISATION PAR JOUR	TORNADO ROtech 1750 W	CARTA PAPER PAPIEL	COTONE COTTON COTON	 2400 W
100	€ 64,30 / anno	€ 876,00	€ 744,60	€ 250,35
200	€ 128,60 / anno	€ 1.752,00	€ 1.489,20	€ 500,71
400	€ 257,20 / anno	€ 3.504,00	€ 2.978,40	€ 1.001,41



Calcoli basati su 365 giorni/anno. Costo dell'energia 0,361 €/kWh. Costo salvietta di carta monouso € 0,008, con una media di 3 salviette per asciugatura. Costo asciugatura con rotolo di cotone € 0,0204 (escluso canone dispenser).



Counts are based on 365 days per year. Energy cost 0,361 €/kWh. The average cost of a paper towel is € 0,008 (3 paper towel sheets per user). The average cost of a cotton towel is € 0,0204 (dispenser fee excluded).



Calculs basés sur 365 jours/an. Coût énergétique de 0,361 €/kWh. Les serviettes en papier jetables coûtent € 0,008 avec une moyenne de 3 lingettes par séchage. Coût du serviettes en coton de € 0,0204 (frais de location du distributeur exclus).

CARATTERISTICHE TECNICHE / TECHNICAL FEATURES / CARACTÉRISTIQUES TECHNIQUES

Funzionamento	Automatico
Functioning	Automatic
Activation	Automatique
Ciri al minuto	
Tr min	28000 rpm
Révolutions par minute	
Grado di protezione elettrica	
Electrical Protection Level	IP31 - CLASS II
Isolation électrique	
Tensione	
Supply Voltage	220 V-240 V
Tension d'alimentation	
Potenza totale	
Total power	1750 W
Puissance totale	
Potenza resistenza	Nessuna resistenza
Absorption Heating Element	No heating element
Puissance chauffage	Pas de chauffage
Potenza motore	
Absorption Motor	875 W (ciascuno) / 1750 W totali
Puissance moteur	
Dimensioni A x L x P	
Dimensions H x W x D	650 x 300 x 230 (mm)
Dimensions H x L x P	
Frequenza	
Frequency	50-60 Hz
Fréquence	
Velocità aria	
Air Speed	410 km/h
Vitesse d'air	

Volume aria	
Air Flow	2x 150 m ³ /h
Débit d'air	
Peso	
Weight	9,5 Kg
Poids net	
Materiale	
Materials	ABS
Matériel	
Marchi di qualità	
Quality marks - certifications	CE
Certification	
Rumorosità (2 mt)	
Noise Level (2 mt)	80 dB
Niveau sonore (2 mt)	
Garanzia	3 anni *
Warranty	3 years *
Garantie	3 ans *

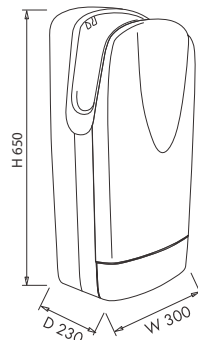

ALTEZZA DI INSTALLAZIONE DA TERRA
PUNTO DI INSERIMENTO DELLE MANI
INSTALLATION HEIGHT FROM FLOOR
POINT OF ENTRY OF HANDS
HAUTEUR D'INSTALLATION DE PLANCHER
POINT D'ENTRÉE DES MAINS

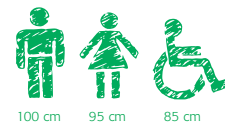

* Per le limitazioni di garanzia si vedano le condizioni generali di servizio

* Limited warranty. Please have a look to the General Warranty Conditions for details and consumables

* Limitations de garantie: revoir Conditions de Garantie Generale



Stream Dry UV



VELOCITÀ ASCIUGATURA

DRYING TIME / TEMPS DE SÉCHAGE



RISPARMIO ENERGETICO

ENERGY SAVING / ÉPARGNE ENERGETIQUE



SILENZIOSITÀ

NOISELESS / SILENCIEUX



DESIGN



ANTIVANDALISMO

ANTIVANDALISM / ANTIVANDALISME



STREAM DRY UV

ECO-JET DRYERS

ASCIUGAMANI - HAND DRYERS - SÈCHE-MAINS

Stream Dry UV

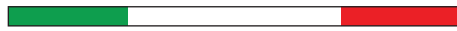

MADE IN ITALY



550 W - 1100 W



Anti-covid
tested filter



STREAM DRY UV

ASCIUGAMANI - HAND DRYERS - SÈCHE-MAINS

VELOCITÀ ed EFFICACIA

Tempo di asciugatura in 15 sec.



ULTRA - FAST DRYING TIME

High speed hand dryer, drying time 15 sec.

RAPIDITÉ ET EFFICACITÉ

Temps de séchage en 15 secondes

EFFICIENZA ENERGETICA

Massimo risparmio energetico, solo 550 W*

* 550 W con resistenza spenta - 1100 W con resistenza accesa



ENERGY EFFICIENCY

Energy efficient hand dryer, rated power 550 W*

* 550 heating element OFF - 1100 W with heating element ON

EFFICACITÉ ÉNERGÉTIQUE

Économie d'énergie maximale, consommation 550 W*

* 550 W avec résistance désactivée et variateur au minimum - 1100 W avec résistance activée

IGIENE e SICUREZZA

Igiene garantita dalla filtrazione dell'aria e dalla sanificazione dei componenti interni



HYGIENE and SAFETY

Engineered for hygienic performance, air flow filtering and UV-C disinfection (24/7)

HYGIÈNE ET SÉCURITÉ

Hygiène garantie par la filtration de l'air et la désinfection des composants internes

COMFORT

Variatore per la regolazione della potenza e della rumorosità (opzionale)



COMFORT

Adjustable energy consumption, noise level and drying time (option)

CONFORT

Variateur pour la régulation de la puissance et du bruit (en option)

DESIGN ELEGANTE

STYLISH DESIGN

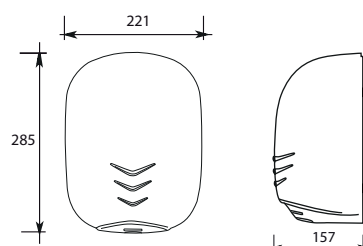

DESIGN ÉLÉGANT





STREAM DRY UV

ECO-JET DRYERS

ASCIUGAMANI - HAND DRYERS - SÈCHE-MAINS

-  **ARTICOLI & CODICI PRODOTTI**
-  **MODEL REFERENCE CHART**
-  **TABLEAU DES MODÈLE DE RÉFÉRENCE**

-  **FILTRO EPA INCLUSO**
-  **EPA FILTER INCLUDED**
-  **FILTRE EPA INCLUS**



Cod.

STREAM DRY UV ABS	Polipropilene bianco / Polypropylene white / Polypropylène blanc
STREAM DRY UV BF	Acciaio verniciato bianco / Stainless steel white / Acier blanc
STREAM DRY UV LF	Acciaio inox AISI 304 lucido / Bright AISI 304 stainless steel / Acier inox Aisi 304 brillant
STREAM DRY UV SF	Acciaio inox AISI 304 satinato / Satin AISI 304 stainless steel / Acier AISI 304 satin
STREAM DRY UV NF	Acciaio con verniciatura nera / Black metallic paint / Acier avec peinture métallisée noire



ABS



BF



SF



LF





NF





tested
Anti-Covid19 filter





-  **FILTRO EPA E11:**
garantisce protezione contro il 97,66% di virus e batteri
-  **EPA FILTER E11:**
allow protection against 97,66% of viruses and bacteria
-  **FILTRE EPA E11:**
Assure une protection contre 97,66% des virus et bactéries





-  **LAMPADA UV-C:**
per disinfezione del condotto di ventilazione
-  **UV-C LAMP:**
for internal parts disinfection
-  **LAMPADE UV-C:**
pour disinfection de la chambre d-air

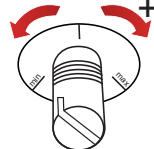

-  **RESISTENZA ON-OFF**
-  **HEATING ON-OFF**
-  **CHAUFFAGE ON-OFF**



-  **VARIATORE*:**
per regolazione potenza motore e rumorosità
 -  **VARIABLE SPEED:**
adjustable energy consumption, noise level and drying time
 -  **VARIATEUR:**
pour réguler la puissance et le bruit du moteur
- * opzionale / option / en option

STREAM DRY UV

ASCIUGAMANI - HAND DRYERS - SÈCHE-MAINS

- CONFRONTO COSTI DI ASCIUGATURA ANNUALI
- ANNUAL SAVINGS CALCULATIONS
- CALCULEZ VOS COÛTS/ECONOMIES ANNUELLES

N° UTILIZZI GIORNALIERI DAILY USE UTILISATION PAR JOUR	Stream Dry UV 1100 W	CARTA PAPER PAPIER	COTONE COTTON COTON	 2400 W
100	€ 48,21/anno	€ 876,00	€ 744,60	€ 250,35
200	€ 96,45/anno	€ 1.752,00	€ 1.489,20	€ 500,71
400	€ 192,90/anno	€ 3.504,00	€ 2.978,40	€ 1.001,41



Calcoli basati su 365 giorni/anno. Costo dell'energia 0,361 €/kWh. Costo salvietta di carta monouso € 0,008, con una media di 3 salviette per asciugatura. Costo asciugatura con rotolo di cotone € 0,0204 (escluso canone dispenser).



Counts are based on 365 days per year. Energy cost 0,361 €/kWh. The average cost of a paper towel is € 0,008 (3 paper towel sheets per user). The average cost of a cotton towel is € 0,0204 (dispenser fee excluded).



Calculs basés sur 365 jours/an. Coût énergétique de 0,361 €/kWh. Les serviettes en papier jetables coûtent € 0,008 avec une moyenne de 3 lingettes par séchage. Coût du serviettes en coton de € 0,0204 (frais de location du distributeur exclus).

CARATTERISTICHE TECNICHE / TECHNICAL FEATURES / CARACTÉRISTIQUES TECHNIQUES

Funzionamento	Sensore di rilevam. elettronico a raggi infrarossi
Functioning	Sensor operating
Activation	Capteur électronique
Giri al minuto	
Tr min	26000 rpm
Révolutions par minute	
Grado di protezione elettrica	
Electrical Protection Level	IP23 - CLASS II
Isolation électrique	
Tensione	
Supply Voltage	220 V-240 V
Tension d'alimentation	
Potenza totale	
Total power	1100 W
Puissance totale	
Potenza resistenza	
Absorption Heating Element	550 W (ON-OFF)
Puissance chauffage	
Potenza motore	
Absorption Motor	550 W
Puissance moteur	
Dimensioni A x L x P	
Dimensions H x W x D	285 X 221 X 157 mm
Dimensions H x L x P	
Frequenza	
Frequency	50-60 Hz
Fréquence	
Velocità aria	
Air Speed	325 km/h
Vitesse d'air	

Volume aria	
Air Flow	187 m ³ /h
Débit d'air	
Peso	
Weight	2,55 Kg Polipropilene - 3,05 Kg Acciaio Inox
Poids net	
Materiale	Polipropilene - Acciaio Inox AISI 304
Materials	Polipropilene - Stainless steel AISI 304
Matériel	Polipropilene - Acier Inox AISI 304
Marchi di qualità	
Quality marks - certifications	CE
Certification	
Rumorosità (2 mt)	
Noise Level (2 mt)	75 db
Niveau sonore (2 mt)	
Garanzia	3 anni*
Warranty	3 years*
Garantie	3 ans*

Accessori inclusi - Included: FILTRO EPA E11, LAMPADA UV

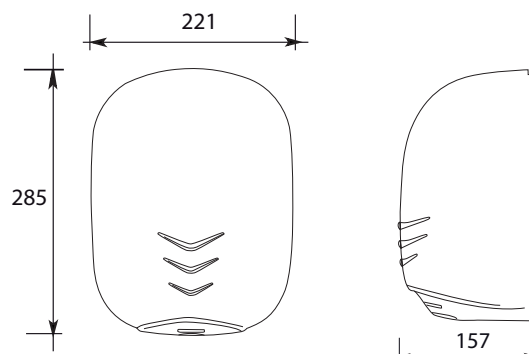

Per le limitazioni di garanzia si vedano le condizioni generali di servizio

Limited warranty. Please have a look to the General Warranty Conditions for details ans consumable

Limitations de garantie: revoir Conditions de Garantie Generale





VELOCITÀ ASCIUGATURA
DRYING TIME / TEMPS DE SÉCHAGE



RISPARMIO ENERGETICO
ENERGY SAVING / ÉPARGNE ENERGETIQUE



SILENZIOSITÀ
NOISELESS / SILENCIEUX



DESIGN



ANTIVANDALISMO
ANTIVANDALISM / ANTIVANDALISME



EcoSTREAM EcoFLOW

ECO-JET DRYERS

ASCIUGAMANI - HAND DRYERS - SÈCHE-MAINS



550 W - 1100 W



Anti-covid
tested filter



GUIDA ALLA SCELTA / HOW TO CHOOSE / COMMENT CHOISIR

1

SCEGLI: CONO D'ARIA (ECOstream) o LAMA D'ARIA (ECOflow)?



CHOOSE: HOLE (ECOstream) OR BLADE (ECOflow)?

SELECTIONNER: CONE D'AIR (ECOstream) OU LAME D'AIR (ECOflow)?

2

SCEGLI IL MODELLO

CHOOSE THE MODEL

CHOISISSEZ LE MODÈLE

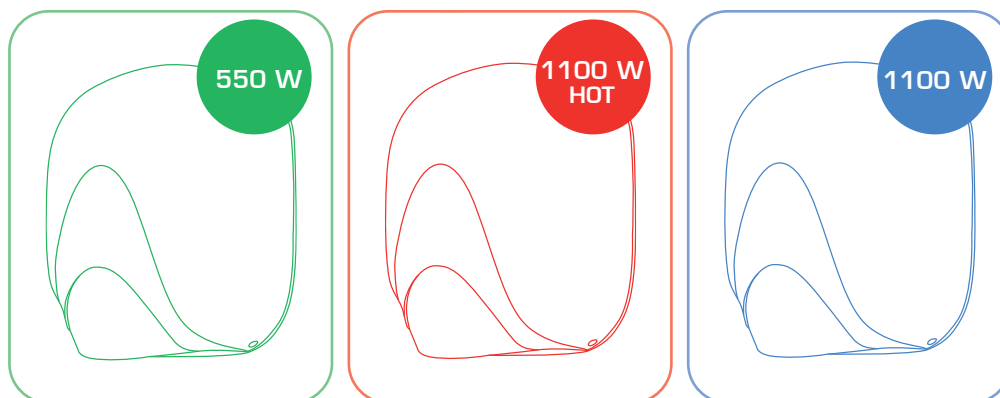

ECOLOGICO: IL MAGGIOR RISPARMIO ENERGETICO

ECO FRIENDLY: ENERGY EFFICIENT

ÉCOLOGIQUE: ÉCONOMIE D'ÉNERGIE ABSOLUE

**ARIA CALDA IMMEDIATA!
MOTORE 550 W +
RESISTENZA 550 W**

**IMMEDIATELY HOT AIR!
550 W MOTOR +
550 W HEATING ELEMENT**

**AIR CHAUD IMMÉDIATEMENT!
550 W MOTEUR +
550 W CHAUFFAGE**

**POTENZA ASSOLUTA:
IL PIÙ VELOCE**

**POWERFUL:
THE FASTEST ONE**

**PUISSANT:
LE PLUS RAPIDE**

3

SCEGLI LA COVER

CHOOSE YOUR FAVOURITE COVER

CHOISISSEZ VOTRE COUVERTURE FAVORITE



ABS bianco, automatico
white ABS, sensor operating
ABS blanc, capteur



alluminio bianco, automatico
white metal, sensor operating
metal blanc, capteur



alluminio satinato, automatico
satin metal, sensor operating
metal satin, capteur



alluminio cromato, automatico
chrome metal, sensor operating
metal chromé, capteur

VELOCITÀ ed EFFICACIA

Tempo di asciugatura in 15 sec.

**ULTRA - FAST DRYING TIME**

High speed hand dryer, drying time 15 sec.

RAPIDITÉ ET EFFICACITÉ

Temps de séchage en 15 secondes

EFFICIENZA ENERGETICA

2 versioni senza resistenza elettrica, con riscaldamento dell'aria progressivo: 550W (massima efficienza) oppure 1100W (massima velocità). Versione 1100 HOT con resistenza elettrica e riscaldamento immediato dell'aria (massimo comfort per l'utente)

**ENERGY EFFICIENCY**

2 non heated models: 550W (the most efficient) or 1100W (the fastest)
Heated version 1100 HOT (the most comfortable)

EFFICACITÉ ÉNERGÉTIQUE

2 Versions sans résistance électrique, avec chauffage progressif de l'air: 550 W (efficacité maximale) ou 1100 W (vitesse maximale). Version 1100 HOT avec résistance électrique et chauffage immédiat de l'air (confort maximal pour l'utilisateur)

IGIENE e SICUREZZA

No touch: azionamento automatico, igiene garantita dalla filtrazione dell'aria (opzione)

**HYGIENE and SAFETY**

Touchless sensor operation, air flow filtering (option)

HYGIÈNE ET SÉCURITÉ

Système de contrôle intelligent "sans contact", hygiène garantie par la filtration de l'air (en option)

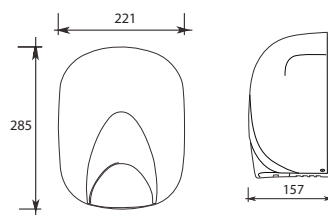
DESIGN ELEGANTE**STYLISH DESIGN****DESIGN ÉLÉGANT****COVER IN ALLUMINIO CON VERNICIATURA DI COLORE NERO METALLIZZATO, FINITURA GOFFRATA**

DISPONIBILE PER TUTTE LE VERSIONI 550 - 1100 - 1100 HOT

METAL COVER, BLACK METALLIC PAINT, EMBOSSED FINISH

AVAILABLE FOR ALL VERSIONS 550 - 1100 - 1100 HOT

COVER EN METAL AVEC PEINTURE MÉTALLISÉE NOIRE, FINITION EN RELIEF



DISPONIBLE POUR TOUTES LES VERSIONS 550 - 1100 - 1100 HOT



EcoSTREAM EcoFlow

ECO-JET DRYERS

ASCIUGAMANI - HAND DRYERS - SÈCHE-MAINS

-  **ARTICOLI & CODICI PRODOTTO**
-  **MODEL REFERENCE CHART**
-  **TABLEAU DES MODÈLE DE RÉFÉRENCE**



Cod.	Mod.			Cod.	Mod.		
EST ABS 550	ECOstream	ABS Bianco / White / Blanc	550W	EFL ABS 550	ECOflow	ABS Bianco / White / Blanc	550W
EST ABS 1100	ECOstream	ABS Bianco / White / Blanc	1100W	EFL ABS 1100	ECOflow	ABS Bianco / White / Blanc	1100W
EST BF 550	ECOstream	Metallo Bianco White metal / Metal blanc	550W	EFL BF 550	ECOflow	Metallo Bianco White metal / Metal blanc	550W
EST BF 1100	ECOstream	Metallo Bianco White metal / Metal blanc	1100W	EFL BF 1100	ECOflow	Metallo Bianco White metal / Metal blanc	1100W
EST LF 550	ECOstream	Metallo Cromato Chrome metal / Metal chromé	550W	EFL LF 550	ECOflow	Metallo Cromato Chrome metal / Metal chromé	550W
EST LF 1100	ECOstream	Metallo Cromato Chrome metal / Metal chromé	1100W	EFL LF 1100	ECOflow	Metallo Cromato Chrome metal / Metal chromé	1100W
EST SF 550	ECOstream	Metallo Satinato Satin metal / Metal satin	550W	EFL SF 550	ECOflow	Metallo Satinato Satin metal / Metal satin	550W
EST SF 1100	ECOstream	Metallo Satinato Satin metal / Metal satin	1100W	EFL SF 1100	ECOflow	Metallo Satinato Satin metal / Metal satin	1100W
EST NF 550	ECOstream	Metallo Nero Black metal / Metal noir	550W	EST NF 550	ECOflow	Metallo Nero Black metal / Metal noir	550W
EST NF 1100	ECOstream	Metallo Nero Black metal / Metal noir	1100W	EST NF 1100	ECOflow	Metallo Nero Black metal / Metal noir	1100W



Cod.	Mod.			Cod.	Mod.		
EST ABS 1100 HOT	ECOstream	ABS Bianco / White / Blanc	1100W	EFL ABS 1100 HOT	ECOflow	ABS Bianco / White / Blanc	1100W
EST BF 1100 HOT	ECOstream	Metallo Bianco White metal / Metal blanc	1100W	EFL BF 1100 HOT	ECOflow	Metallo Bianco White metal / Metal blanc	1100W
EST LF 1100 HOT	ECOstream	Metallo Cromato Chrome metal / Metal chromé	1100W	EFL LF 1100 HOT	ECOflow	Metallo Cromato Chrome metal / Metal chromé	1100W
EST SF 1100 HOT	ECOstream	Metallo Satinato Satin metal / Metal satin	1100W	EFL SF 1100 HOT	ECOflow	Metallo Satinato Satin metal / Metal satin	1100W
EST NF 1100 HOT	ECOstream	Metallo Nero Black metal / Metal noir	1100W	EFL NF 1100 HOT	ECOflow	Metallo Nero Black metal / Metal noir	1100W



OPZIONE FILTRO EPA E11 (TUTTI I MODELLI)
EPA E11 FILTER OPTION (ALL MODELS)
FILTRE EPA E11 EN OPTION (TOUS LES MODÈLES)



tested
Anti-Covid19 filter

ASCIUGAMANI - HAND DRYERS - SÈCHE-MAINS

- CONFRONTO COSTI DI ASCIUGATURA ANNUALI
- ANNUAL SAVINGS CALCULATION
- CALCULEZ VOS COÛTS/ECONOMIES ANNUELLES

N° UTILIZZI GIORNALIERI DAILY USE UTILISATION PAR JOUR	ECOSTREAM ECOFLOW 1100W	ECOSTREAM ECOFLOW 550W	CARTA PAPER PAPIER	COTONE COTTON COTON	 2400 W
	ECOSTREAM ECOFLOW 1100W				
100	€ 48,21/anno	€ 30,30/anno	€ 876,00	€ 744,60	€ 250,35
200	€ 96,45/anno	€ 60,61/anno	€ 1.752,00	€ 1.489,20	€ 500,71
400	€ 192,90/anno	€ 121,22/anno	€ 3.504,00	€ 2.978,40	€ 1.001,41



Calcoli basati su 365 giorni/anno. Costo dell'energia 0,361 €/kWh. Costo salvietta di carta monouso € 0,008, con una media di 3 salviette per asciugatura. Costo asciugatura con rotolo di cotone € 0,0204 (escluso canone dispenser).



Counts are based on 365 days per year. Energy cost 0,361 €/kWh. The average cost of a paper towel is € 0,008 (3 paper towel sheets per user). The average cost of a cotton towel is € 0,0204 (dispenser fee excluded).



Calculs basés sur 365 jours/an. Coût énergétique de 0,361 €/kWh. Les serviettes en papier jetables coûtent € 0,008 avec une moyenne de 3 lingettes par séchage. Coût du serviettes en coton de € 0,0204 (frais de location du distributeur exclus).

CARATTERISTICHE TECNICHE / TECHNICAL FEATURES / CARACTÉRISTIQUES TECHNIQUES

Funzionamento	Automatico	Volume aria	
Functioning	Automatic	Air Flow	187 m ³ /h (1100 W), 126 m ³ /h (550 W)
Activation	Automatique	Débit d'air	
Ciri al minuto		Peso	
Tr min	30000 rpm (1100 W) - 26000 rpm (550 W)	Weight	5,00 Kg (Metallo) - 3,00 Kg (ABS)
Révolutions par minute		Poids net	
Grado di protezione elettrica		Materiale	ABS - Alluminio pressofuso
Electrical Protection Level	IP23 - CLASS II	Materials	ABS - Die Cast Aluminium
Isolation électrique		Matériel	ABS - en fonte d'aluminium
Tensione		Marchi di qualità	
Supply Voltage	220 V-240 V	Quality marks - certifications	CE
Tension d'alimentation		Certification	
Potenza totale		Rumorosità (2 mt)	
Total power	1100 W - 550 W	Noise Level (2 mt)	80 db (1100 W) 75 db (550 W)
Puissance totale		Niveau sonore (2 mt)	
Potenza resistenza		Garanzia	3 anni*
Absorption Heating Element	550 W (solo - only - seule mod. HOT)	Warranty	3 years*
Puissance chauffage		Garantie	3 ans*
Potenza motore			
Absorption Motor	1100 W - 550 W		
Puissance moteur			
Dimensioni A x L x P			
Dimensions H x W x D	285 X 221 X 157 mm		
Dimensions H x L x P			
Frequenza			
Frequency	50-60 Hz		
Fréquence			
Velocità aria			
Air Speed	325 km/h (1100 W) - 250 km/h (550 W)		
Vitesse d'air			

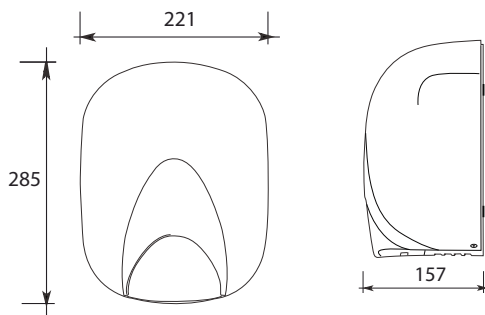

* Per le limitazioni di garanzia si vedano le condizioni generali di servizio

* Limited warranty. Please have a look to the General Warranty Conditions for details and consumables

* Limitations de garantie: revoir Conditions de Garantie Generale



smart jet mini



VELOCITÀ ASCIUGATURA
DRYING TIME / TEMPS DE SÉCHAGE



RISPARMIO ENERGETICO
ENERGY SAVING / ÉPARGNE ENERGETIQUE



SILENZIOSITÀ
NOISELESS / SILENCIEUX



DESIGN



ANTIVANDALISMO
ANTIVANDALISM / ANTIVANDALISME



SMART JET MINI

ECO-JET DRYERS

ASCIUGAMANI - HAND DRYERS - SÈCHE MAINS

smart jet mini



 **VELOCITÀ ed EFFICACIA**
Tempo di asciugatura in 20 sec.



 **ULTRA - FAST DRYING TIME**
High speed hand dryer, drying time 20 sec.

 **RAPIDITÉ ET EFFICACITÉ**
Temps de séchage en 20 secondes

 **EFFICIENZA ENERGETICA**
Massimo risparmio energetico, solo 900 W



 **ENERGY EFFICIENCY**
Energy efficient hand dryer, rated power 900 W

 **EFFICACITÉ ÉNERGÉTIQUE**
Économie d'énergie maximale, consommation 900 W

 **IGIENE e SICUREZZA**
No touch: azionamento automatico
Igiene garantita dalla filtrazione dell'aria (opzione)



 **HYGIENE and SAFETY**
Touchless sensor operation
Air flow filtering (option)

 **HYGIÈNE ET SÉCURITÉ**
Système de contrôle intelligent "sans contact"
Hygiène garantie par la filtration de l'air (en option)

 **DESIGN ELEGANTE**
Il più piccolo eco-jet dryer al mondo: profondità inferiore a 10 cm.!!!





 **STYLISH DESIGN**
The smallest existing eco-jet dryer: depth lower than 10 cm.!!!



 **DESIGN ÉLÉGANT**
Le plus petit séchoir eco-jet au monde: profondeur inférieure à 10 cm.!!!





SMART JET MINI BF

 ABS bianco, automatico
 White ABS, sensor operating
 ABS blanc, capteur





SMART JET MINI SF

 ABS satinato, automatico
 Satin ABS, sensor operating
 ABS chromé brossé, capteur





SMART JET MINI LF

 ABS lucido, automatico
 Chrome ABS, sensor operating
 ABS chromé, capteur



SMART JET MINI NF

 ABS nero, automatico
 Black ABS, sensor operating
 ABS noir, capteur

ASCIUGAMANI - HAND DRYERS - SÈCHE-MAINS

- CONFRONTO COSTI DI ASCIUGATURA ANNUALI
- ANNUAL SAVINGS CALCULATION
- CALCULEZ VOS COÛTS/ECONOMIES ANNUELLES

N° UTILIZZI GIORNALIERI DAILY USE UTILISATION PAR JOUR	 900 W	CARTA PAPER PAPIEL	COTONE COTTON COTON	 2400 W
100	€ 38,20/anno	€ 876,00	€ 744,60	€ 250,35
200	€ 76,42/anno	€ 1.752,00	€ 1.489,20	€ 500,71
400	€ 152,85/anno	€ 3.504,00	€ 2.978,40	€ 1.001,41



Calcoli basati su 365 giorni/anno. Costo dell'energia 0,361 €/kWh. Costo salvietta di carta monouso € 0,008, con una media di 3 salviette per asciugatura. Costo asciugatura con rotolo di cotone € 0,0204 (escluso canone dispenser).



Counts are based on 365 days per year. Energy cost 0,361 €/kWh. The average cost of a paper towel is € 0,008 (3 paper towel sheets per user). The average cost of a cotton towel is € 0,0204 (dispenser fee excluded).



Calculs basés sur 365 jours/an. Coût énergétique de 0,361 €/kWh. Les serviettes en papier jetables coûtent € 0,008 avec une moyenne de 3 lingettes par séchage. Coût du serviettes en coton de € 0,0204 (frais de location du distributeur exclus).

CARATTERISTICHE TECNICHE / TECHNICAL FEATURES / CARACTÉRISTIQUES TECHNIQUES

Funzionamento	Automatico
Functioning	Automatic
Activation	Automatique
Giri al minuto	
Tr min	28000 rpm
Révolutions par minute	
Grado di protezione elettrica	
Electrical Protection Level	IP23 - CLASS II
Isolation électrique	
Tensione	
Supply Voltage	220 V-240 V
Tension d'alimentation	
Volume aria	
Air Flow	110 m ³ /h
Débit d'air	
Potenza totale	
Total power	900 W
Puissance totale	
Potenza resistenza	
Absorption Heating Element	500 W
Puissance chauffage	
Potenza motore	
Absorption Motor	400 W
Puissance moteur	
Dimensioni A x L x P	
Dimensions H x W x D	238 x 156 x 99,5 (mm)
Dimensions H x L x P	
Frequenza	
Frequency	50-60 Hz
Fréquence	

Velocità aria	
Air Speed	200 km/h
Vitesse d'air	
Peso	
Weight	1,2 Kg
Poids net	
Materiale	
Materials	ABS
Matériel	
Marchi di qualità	
Quality marks - certifications	CE RoHS WEEE
Certification	
Rumorosità (2 mt)	
Noise Level (2 mt)	75 dB
Niveau sonore (2 mt)	
Garanzia	3 anni *
Warranty	3 years *
Garantie	3 ans *

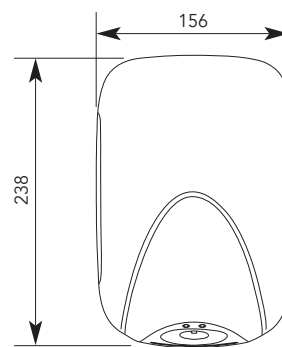

- * Per le limitazioni di garanzia si vedano le condizioni generali di servizio
- * Limited warranty. Please have a look to the General Warranty Conditions for details and consumables
- * Limitations de garantie: revoir Conditions de Garantie Generale

LASER

FLOW



LASER FLOW

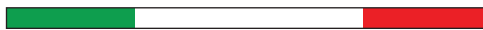

M A D E I N I T A L Y



410 km/h



900 W - 1450 W



Anti-covid
tested filter



VELOCITÀ ed EFFICACIA

Tempo di asciugatura in 15 sec.



ULTRA - FAST DRYING TIME

High speed hand dryer, drying time 15 sec.

RAPIDITÉ ET EFFICACITÉ

Temps de séchage en 15 secondes

EFFICIENZA ENERGETICA

Massimo risparmio energetico, solo 900 W*

* 900 W con resistenza spenta - 1450 W con resistenza accesa



ENERGY EFFICIENCY

Energy efficient hand dryer, rated power 900 W*

* 900 heating element OFF - 1450 W with heating element ON

EFFICACITÉ ÉNERGÉTIQUE

Économie d'énergie maximale, consommation 900 W*

* 900 W avec résistance désactivée et variateur au minimum -1450 W avec résistance activée

IGIENE e SICUREZZA

Igiene garantita dalla filtrazione dell'aria e dalla sanificazione dei componenti interni



HYGIENE and SAFETY

Engineered for hygienic performance, air flow filtering and UV-C disinfection (24/7)

HYGIÈNE ET SÉCURITÉ

Hygiène garantie par la filtration de l'air et la désinfection des composants internes

DESIGN ELEGANTE



STYLISH DESIGN

DESIGN ÉLÉGANT

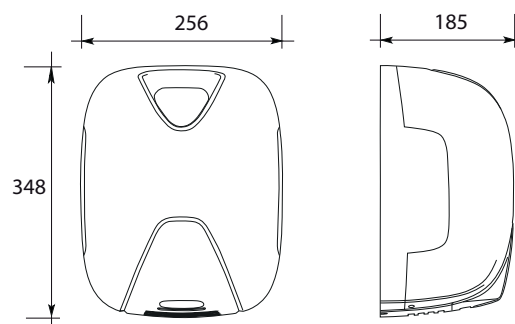





-  **ARTICOLI & CODICI PRODOTTO**
-  **MODEL REFERENCE CHART**
-  **TABLEAU DES MODÈLE DE RÉFÉRENCE**



Cod.	Mod.	Colore	Motore 900 WATT	Resistenza 550 WATT	UV LAMP
UV BASIC BF	LASERFLOW	ABS Bianco / White / Blanc	TOP-AC	ON-OFF	ON-OFF
UV BASIC SF	LASERFLOW	ABS Grigio / Grey / Gris	TOP-AC	ON-OFF	ON-OFF



LAMPADA UV DA 3 WATT PER DISINFEZIONE DEL CONDOTTO DI VENTILAZIONE
 UV LAMP 3 WATT FOR AIR ENCLOSURE DISINFECTION
 LAMPADRE UV POUR DISINFECTION DE LA CHAMBRE D'AIR



Il filtro EPA E11 garantisce protezione contro il 97,66% di virus e batteri

EPA E11 filter allow protection against 97,66% of viruses and bacteria

Le filtre EPA E11 Assure une protection contre 97,66% des virus et bactéries



ASCIUGAMANI - HAND DRYERS - SÈCHE-MAINS

- CONFRONTO COSTI DI ASCIUGATURA ANNUALI
- ANNUAL SAVINGS CALCULATION
- CALCULEZ VOS COÛTS/ECONOMIES ANNUELLES

LASERFLOW

N° UTILIZZI GIORNALIERI <i>DAILY USE</i> UTILISATION PAR JOUR	LASERFLOW	CARTA PAPER PAPIER	COTONE COTTON COTON	 2400 W
	1450 W			
100	€ 56,26/anno	€ 876,00	€ 744,60	€ 250,35
200	€ 112,52/anno	€ 1.752,00	€ 1.489,20	€ 500,71
400	€ 225,05/anno	€ 3.504,00	€ 2.978,40	€ 1.001,41



Calcoli basati su 365 giorni/anno. Costo dell'energia 0,361 €/kWh. Costo salvietta di carta monouso € 0,008, con una media di 3 salviette per asciugatura. Costo asciugatura con rotolo di cotone € 0,0204 (escluso canone dispenser).



Counts are based on 365 days per year. Energy cost 0,361 €/kWh. The average cost of a paper towel is € 0,008 (3 paper towel sheets per user). The average cost of a cotton towel is € 0,0204 (dispenser fee excluded).



Calculs basés sur 365 jours/an. Coût énergétique de 0,361 €/kWh. Les serviettes en papier jetables coûtent € 0,008 avec une moyenne de 3 lingettes par séchage. Coût du serviettes en coton de € 0,0204 (frais de location du distributeur exclus).

CARATTERISTICHE TECNICHE / TECHNICAL FEATURES / CARACTÉRISTIQUES TECHNIQUES

Funzionamento	Automatico	Volume aria	
Functioning	Automatic	Air Flow	250 m ³ /h
Activation	Automatique	Débit d'air	
Giri al minuto		Peso	
Tr min	26000 rpm	Weight	5,00 Kg
Révolutions par minute		Poids net	
Grado di protezione elettrica		Materiale	
Electrical Protection Level	IP34 - CLASS II	Materials	ABS - Nylon
Isolation électrique		Matériel	
Tensione		Marchi di qualità	
Supply Voltage	220 V-240 V	Quality marks - certifications	CE
Tension d'alimentation		Certification	
Potenza totale		Rumorosità (2 mt)	
Total power	900 W - 1450 W	Noise Level (2 mt)	75 db
Puissance totale		Niveau sonore (2 mt)	
Potenza resistenza		Garanzia	3 anni*
Absorption Heating Element	550 W	Warranty	3 years*
Puissance chauffage		Garantie	3 ans*
Potenza motore			
Absorption Motor	900 W		
Puissance moteur			
Dimensioni A x L x P			
Dimensions H x W x D	348 X 256 X 185 mm		
Dimensions H x L x P			
Frequenza			
Frequency	50-60 Hz		
Fréquence			
Velocità aria			
Air Speed	410 km/h		
Vitesse d'air			

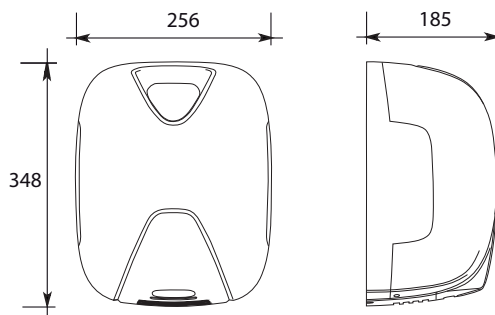

* Per le limitazioni di garanzia si vedano le condizioni generali di servizio

* Limited warranty. Please have a look to the General Warranty Conditions for details and consumables

* Limitations de garantie: revoir Conditions de Garantie Generale

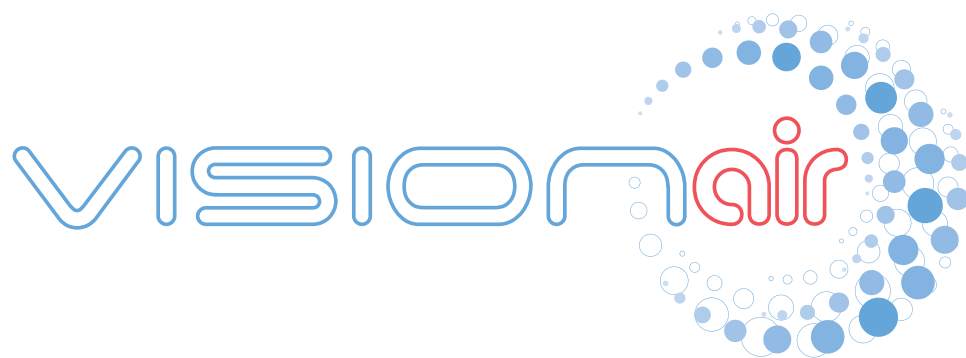

VELOCITÀ ASCIUGATURA
DRYING TIME / TEMPS DE SÉCHAGE



RISPARMIO ENERGETICO
ENERGY SAVING / ÉPARGNE ENERGETIQUE



SILENZIOSITÀ
NOISELESS / SILENCIEUX



DESIGN



ANTIVANDALISMO
ANTIVANDALISM / ANTIVANDALISME



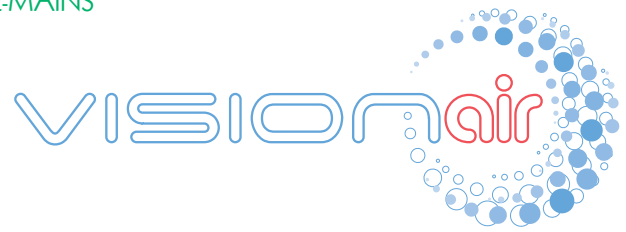

MADE IN ITALY



Anti-covid
tested filter



 **VELOCITÀ ed EFFICACIA**
Tempo di asciugatura super veloce in 15 sec.



 **ULTRA - FAST DRYING TIME**
High speed hand dryer, drying time 15 sec.

 **RAPIDITÉ ET EFFICACITÉ**
Temps de séchage ultra rapide en 15 secondes

 **EFFICIENZA ENERGETICA**
Assenza di resistenza elettrica, riscaldamento dell'aria per compressione ed attraverso il calore dei motori



 **ENERGY EFFICIENCY**
No heating element: air heating through compression and engines warming

 **EFFICACITÉ ÉNERGÉTIQUE**
Absence de résistance électrique: chauffage de l'air grâce à la compression et à la chaleur des moteurs

 **IGIENE e SICUREZZA**
No touch: azionamento automatico all'inserimento delle mani
Vaschetta di raccolta d'acqua: nessun gocciolamento sui pavimenti
Igiene garantita dalla filtrazione dell'aria



 **HYGIENE and SAFETY**
Touchless sensor operation
Inbuilt water tank prevents wet floor hazards
Air flow filtering

 **HYGIÈNE ET SÉCURITÉ**
Système de contrôle intelligent "sans contact"
Reservoir de collecte d'eau, prévient les risques de sol mouillé
Hygiène garantie par la filtration de l'air

 **DESIGN ERGONOMICO & INNOVATIVO**
Modalità di utilizzo con inserimento delle mani in orizzontale, che abbina l'ergonomia alla facilità d'utilizzo per tutte le fasce d'utenza.



 **CUSTOMER-ORIENTED DESIGN**
Hands through drying style, which combines ergonomics and accessibility

 **DESIGN ERGONOMIQUE**
L'insertion des mains à l'horizontale combine l'ergonomie et l'accessibilité pour tous les groupes d'utilisateurs.



ASCIUGAMANI - HAND DRYERS - SÈCHE-MAINS



 Inserimento orizzontale delle mani

 Hands through drying style

 La conception ergonomique permet l'insertion des mains d'une manière naturelle.

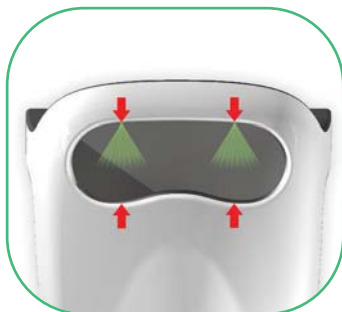

Doppio sensore di avvio*

Double sensor operating*

Double capteur électronique*

* PRO setting (pag. 16)





Asciugatura superveloce con 4 lame d'aria circolari

4 air nozzles for fastest hand drying

Les 4 prises d'air permettent au flux d'air de sécher avec une efficacité maximale grâce à un petit massage



 Versioni in ABS colore bianco (BF) e grigio (SF)

 White (BF) and grey (SF) ABS

 ABS blanc (BF) et ABS gris (SF)



L'acqua viene canalizzata nella vaschetta di raccolta alla base dell'apparecchio, evitando il gocciolamento a terra e consentendo il massimo dell'igiene e della sicurezza

The water tank avoids dripping on floors, pollution and bad smells. Ready and fast to empty and clean, it is warranty of maximum hygiene

L'eau est canalisée dans le bac de collecte à la base de l'appareil, en évitant les gouttes sur le sol, donnant une meilleure hygiène et une sécurité maximale



LED per monitoraggio del ciclo di asciugatura: stand-by; in funzione; fine ciclo.

Sensori luminosi per una veloce diagnosi dello stato di funzionamento: 1) sensore per pulizia filtro EPA E11; 2) sensore per avviso di svuotamento vaschetta; 3) sensore per check motore (consumo spazzole)*



Luminous LED for a quick check of the drying cycle: stand-by; operating; cycle end.

Luminous frontal LED for a quick diagnosis of the hand dryer status: 1) EPA E11 filter check sensor; 2) full water tank sensor; 3) motor brushes check sensor*

Lumineux à LED pour un contrôle rapide du cycle de séchage: stand-by; exploitation; fin de cycle.

LED frontales lumineuses pour une rapide diagnostic de l'état de sèche-mains: 1) Avis nettoyage filtre EPA E11; 2) Avis réservoir d'eau plein; 3) Avis change balais de moteur*



-  **ARTICOLI & CODICI PRODOTTO**
-  **MODEL REFERENCE CHART**
-  **TABLEAU DES MODÈLE DE RÉFÉRENCE**



Cod.		Setting	Cod.		Setting
VISION AIR BF EASY	ABS Bianco / White / Blanc	EASY	VISION AIR SF EASY	ABS grigio / grey / gris	EASY
VISION AIR BF PRO	ABS Bianco / White / Blanc	PRO	VISION AIR SF PRO	ABS grigio / grey / gris	PRO





















Il filtro EPA E11 (opzione) garantisce protezione contro il 97,66% di virus e batteri

EPA E11 filter (option) allow protection against 97,66% of viruses and bacteria

Le filtre EPA E11 (en option) Assure une protection contre 97,66% des virus et bactéries



	EASY SETTING	PRO SETTING
<ul style="list-style-type: none">  Sensore di avvio con autospegnimento di sicurezza  <i>Sensor operating, with safety auto turn-off</i>  Capteur électronique avec arrêt automatique de sécurité 	✓	✓
<ul style="list-style-type: none">  Vaschetta di raccolta d'acqua  <i>Water tank</i>  Bac de collecte d'eau 	✓	✓
<ul style="list-style-type: none">  Filtro EPA E11  <i>EPA E11 filter</i>  Filtre EPA E11 	✗ <i>Opzione - Option - En option</i>	✓
<ul style="list-style-type: none">  Doppio sensore di avvio  <i>Double sensor operating</i>  Double capteur électronique 	✗	✓
<ul style="list-style-type: none">  LED per monitoraggio del ciclo di asciugatura  <i>Luminous led for a quick check of the drying cycle</i>  Lumineux à LED pour un contrôle rapide du cycle de séchage 	✗	✓
<ul style="list-style-type: none">  Sensori luminosi: check filtro EPA E11, avviso vaschetta piena, check motore (consumo spazzole)  <i>Luminous leds: EPA E11 filter check sensor, full water tank sensor, motor brushes check sensor</i>  Leds lumineux: check filtre EPA E11, avis réservoir d'eau plein, check balais de moteur 	✗	✓

ASCIUGAMANI - HAND DRYERS - SÈCHE-MAINS

- CONFRONTO COSTI DI ASCIUGATURA ANNUALI
- ANNUAL SAVINGS CALCULATION
- CALCULEZ VOS COÛTS/ECONOMIES ANNUELLES

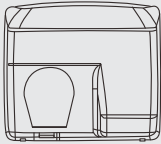
N° UTILIZZI GIORNALIERI DAILY USE UTILISATION PAR JOUR	VISION AIR 1100 W	CARTA PAPER PAPIEL	COTONE COTTON COTON	 2400 W
100	€ 48,21 / anno	€ 876,00	€ 744,60	€ 250,35
200	€ 96,45 / anno	€ 1.752,00	€ 1.489,20	€ 500,71
400	€ 192,90 / anno	€ 3.504,00	€ 2.978,40	€ 1.001,41



Calcoli basati su 365 giorni/anno. Costo dell'energia 0,361 €/kWh. Costo salvietta di carta monouso € 0,008, con una media di 3 salviette per asciugatura. Costo asciugatura con rotolo di cotone € 0,0204 (escluso canone dispenser).



Counts are based on 365 days per year. Energy cost 0,361 €/kWh. The average cost of a paper towel is € 0,008 (3 paper towel sheets per user). The average cost of a cotton towel is € 0,0204 (dispenser fee excluded).



Calculs basés sur 365 jours/an. Coût énergétique de 0,361 €/kWh. Les serviettes en papier jetables coûtent € 0,008 avec une moyenne de 3 lingettes par séchage. Coût du serviettes en coton de € 0,0204 (frais de location du distributeur exclus).

CARATTERISTICHE TECNICHE / TECHNICAL FEATURES / CARACTÉRISTIQUES TECHNIQUES

Funzionamento	Automatico
Functioning	Automatic
Activation	Automatique
Giri al minuto	
Tr min	32000 rpm
Révolutions par minute	
Grado di protezione elettrica	
Electrical Protection Level	IP44 - CLASS II
Isolation électrique	
Tensione	
Supply Voltage	220 V-240 V
Tension d'alimentation	
Volume aria	
Air Flow	187 m ³ /h
Débit d'air	
Potenza totale	
Total power	1100 W
Puissance totale	
Potenza resistenza	Nessuna resistenza
Absorption Heating Element	No heating element
Puissance chauffage	Pas de chauffage
Potenza motore	
Absorption Motor	1100 W
Puissance moteur	
Dimensioni A x L x P	
Dimensions H x W x D	442 x 350 x 233 (mm)
Dimensions H x L x P	
Frequenza	
Frequency	50-60 Hz
Fréquence	

Velocità aria	
Air Speed	425 km/h
Vitesse d'air	
Peso	
Weight	4,5 Kg
Poids net	
Materiale	
Materials	ABS
Matériel	
Marchi di qualità	
Quality marks - certifications	CE RoHS WEEE GOST
Certification	
Rumorosità (2 mt)	
Noise Level (2 mt)	75 dB
Niveau sonore (2 mt)	
Garanzia	3 anni *
Warranty	3 years *
Garantie	3 ans *

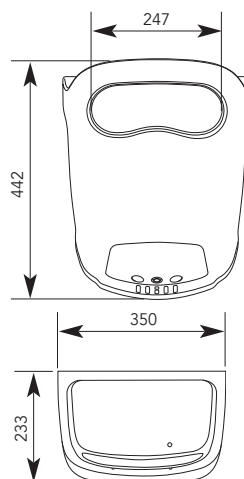

ALTEZZA DI INSTALLAZIONE DA TERRA
PUNTO DI INSERIMENTO DELLE MANI
INSTALLATION HEIGHT FROM FLOOR
POINT OF ENTRY OF HANDS
HAUTEUR D'INSTALLATION DE PLANCHER
POINT D'ENTRÉE DES MAINS



* Per le limitazioni di garanzia si vedano le condizioni generali di servizio

* Limited warranty. Please have a look to the General Warranty Conditions for details and consumables

* Limitations de garantie: revoir Conditions de Garantie Generale

ARIEL



VELOCITÀ ASCIUGATURA

DRYING TIME / TEMPS DE SÉCHAGE



RISPARMIO ENERGETICO

ENERGY SAVING / ÉPARGNE ENERGETIQUE



SILENZIOSITÀ

NOISELESS / SILENCIEUX



DESIGN



ANTIVANDALISMO

ANTIVANDALISM / ANTIVANDALISME



ASCIUGAMANI- HAND DRYERS - SÈCHE-MAINS



- 

Asciugamani antivandalo, potenza 2400 W o nella versione a risparmio energetico 1700 W, con scocca in acciaio e bocchettone girevole a 360°, funzionamento a pulsante o sensore di rilevamento elettronico a raggi infrarossi. Temporizzazione regolabile da 25" a 180". Doppio termostato per la massima sicurezza, sia sulla resistenza che sul motore. Disponibile in acciaio INOX AISI 304 lucido, satinato e nella versione a smalto colore bianco. Personalizzazioni con altri colori a richiesta.
- 

Antivandal hand dryer, power 2400 W or economy version 1700 W, steel cover, 360° revolving nozzle, push button or infrared sensor operating. Adjustable timer between 25" and 180". Double thermostat, on both engine and heating element. Available in white porcelainized, bright or satin INOX AISI 304 steel. Other colors available on request.
- 

Sèche-mains antivandalisme en acier, puissance 2400 W ou 1700 W d'économie, le bouton poussoir ou capteur automatique, avec tuyère orientable 360 degrés. Double thermostat de sécurité, minuterie réglable entre 25" et 180". Disponible en blanc, acier INOX AISI 304 brillant, INOX AISI 304 satin. Autres couleurs disponibles.



ARIEL è disponibile anche nella versione a incasso, con box in acciaio INOX AISI 304 satinato e sistema di chiusura antivandalo. Funzionamento automatico con sistema di autospegnimento antivandalico dopo 60 secondi.

ARIEL is also available in recessed version, with satin AISI 304 stainless steel case, vandal-proof lock screws and key wrench. Automatic operation hand dryer with power cut off in case of irregular use over 60 seconds.

Ariel est également disponible en version encastrée murale, avec une structure en acier inox AISI 304 satiné anti-vandalisme. Système capteur avec l'auto-désactivation anti vandalisme après 60 secondes.

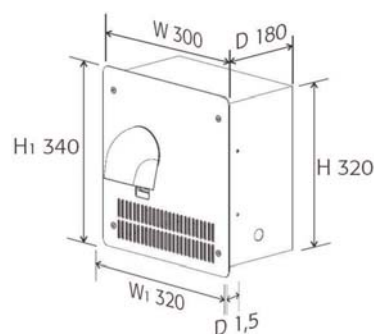

ASCIUGAMANI- HAND DRYERS - SÈCHE-MAINS



ARIEL /BP
Acciaio verniciato bianco,
funzionante a pulsante.
*White steel, push button
operating.*
Acier blanc, bouton poussoir.



ARIEL /SP
Acciaio inox AISI 304 satinato,
funzionante a pulsante.
*Satin AISI 304 stainless steel,
push button operating.*
Acier inox AISI 304 satin,
bouton poussoir.



ARIEL /LP
Acciaio inox AISI 304 lucido,
funzionamento a pulsante.
*Bright AISI 304 stainless steel,
push button operating.*
Acier inox AISI 304 brillant,
bouton poussoir.



ARIEL /BF
Acciaio verniciato bianco,
funzionamento automatico.
*White steel infrared
sensor operating.*
Acier blanc, capteur
electronique.



ARIEL /SF
Acciaio inox AISI 304 satinato,
funzionamento automatico.
*Satin AISI 304 stainless steel,
infrared sensor operating.*
Acier inox AISI 304 satin,
capteur electronique.



ARIEL /LF
Acciaio inox AISI 304 lucido,
funzionamento automatico.
*Bright AISI 304 stainless steel,
infrared sensor operating.*
Acier inox AISI 304 brillant,
capteur electronique.

CARATTERISTICHE TECNICHE / TECHNICAL FEATURES / CARACTÉRISTIQUES TECHNIQUES

Funzionamento	Pulsante o Automatico a sensore
Functioning	Push button or sensor operating
Activation	Poussoir ou capteur electronique
Giri al minuto	
Tr min	5500 rpm
Révolutions par minute	
Grado di protezione elettrica	
Electrical Protection Level	IPX1 - CLASS I
Isolation électrique	
Tensione	
Supply Voltage	220 V-240 V
Tension d'alimentation	
Potenza totale	
Total power	2400 W - 1700 W (energy saving)
Puissance totale	
Potenza resistenza	
Absorption Heating Element	2200 W or 1500 W
Puissance chauffage	
Potenza motore	
Absorption Motor	200 W
Puissance moteur	
Dimensioni A x L x P	
Dimensions H x W x D	243 x 278 x 213 (mm)
Dimensions H x L x P	
Frequenza	
Frequency	50-60 Hz
Fréquence	
Velocità aria	
Air Speed	101 Km/h
Vitesse d'air	

Volume aria	
Air Flow	345 m3/h
Débit d'air	
Peso	
Weight	4,8 Kg - 9,6 Kg ARIEL SCL
Poids net	
Materiale	Acciaio
Materials	Steel
Matériel	Acier
Marchi di qualità	
Quality marks - certifications	CE
Certification	
Rumorosità (2 mt)	
Noise Level (2 mt)	70 dB
Niveau sonore (2 mt)	
Garanzia	3 anni *
Warranty	3 years *
Garantie	3 ans *

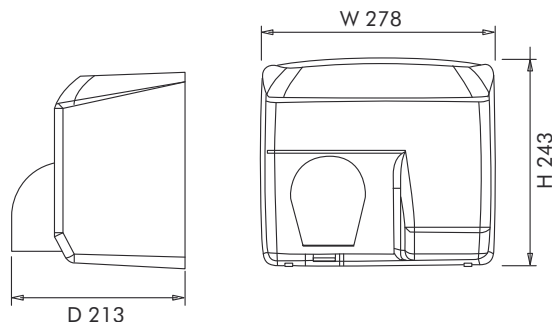

🇮🇹 * Per le limitazioni di garanzia si vedano le condizioni generali di servizio

🇬🇧 * Limited warranty. Please have a look to the General Warranty Conditions for details and consumables

🇫🇷 * Limitations de garantie: revoir Conditions de Garantie Generale



U-nik®



VELOCITÀ ASCIUGATURA
DRYING TIME / TEMPS DE SÉCHAGE



RISPARMIO ENERGETICO
ENERGY SAVING / ÉPARGNE ENERGETIQUE



SILENZIOSITÀ
NOISELESS / SILENCIEUX



DESIGN



ANTIVANDALISMO
ANTIVANDALISM / ANTIVANDALISME



U-nik®



 **L'ASCIUGAMANI SILENZIOSO, AFFIDABILE, CON OTTIMO RAPPORTO QUALITÀ-PREZZO**

- Ideale per aree a traffico medio / ridotto
- Ottimo rapporto tra performance / consumi / budget di spesa
- Massima silenziosità: inferiore a 60 db
- Nessuna manutenzione, motore a induzione
- Timer regolabile tra 30 sec. - 3 min.
- Design contemporaneo e grande varietà di gamma (disponibile in colore bianco, grigio-satinato e cromato-lucido)

 **THE NOISELESS, RELIABLE, CHEAPEST HAND DRYER**

- The best for medium-low transit area
- The best balance between performance / electricity consumption / budget
- Noiseless: less than 60 db
- No need of maintenance, brushless motors
- Adjustable timer (30 sec. - 3 min.)
- Contemporary design and wide range (white, satin-grey, bright)

 **LE SÈCHE-MAINS SILENCIEUX, FIABLE, AVEC UN RAPPORT EXCELLENT QUALITÉ/PRISE**

- Idéal pour les zones de trafic (moyen / faible)
- Bonne relation entre performance / consommation / budget des dépenses
- Niveau de bruit maximum: moins de 60 db
- Pas d'entretien, moteur à induction
- Timer réglable de 30 sec. - 3 min.
- Design contemporain et variété de gamme (disponible en blanc, gris et chromé)



ASCIUGAMANI - HAND DRYERS - SÈCHE-MAINS



UNIK /BP

ABS bianco a pulsante
 ABS white push button
 ABS blanc, bouton poussoir



UNIK /BF

ABS bianco automatico
 ABS white sensor operating
 ABS blanc, capteur électronique



UNIK /SF

ABS grigio, automatico
 ABS grey, sensor operating
 ABS gris, capteur électronique



UNIK /LF

ABS lucido, automatico
 ABS bright, sensor operating
 ABS brillant, capteur électronique



UNIK /NF

ABS nero, automatico
 ABS black, sensor operating
 ABS noir, capteur électronique

CARATTERISTICHE TECNICHE / TECHNICAL FEATURES / CARACTÉRISTIQUES TECHNIQUES

Funzionamento	Pulsante o Automatico a sensore
Functioning	Push button or sensor operating
Activation	Poussoir ou capteur électronique
Giri al minuto	
Tr min	2800 rpm
Révolutions par minute	
Grado di protezione elettrica	
Electrical Protection Level	IPX2 - CLASS II
Isolation électrique	
Tensione	
Supply Voltage	220 V-240 V
Tension d'alimentation	
Potenza totale	
Total power	1850 W
Puissance totale	
Potenza resistenza	
Absorption Heating Element	1785 W
Puissance chauffage	
Potenza motore	
Absorption Motor	65 W
Puissance moteur	
Dimensioni A x L x P	
Dimensions H x W x D	305 x 262 x 165 (mm)
Dimensions H x L x P	
Frequenza	
Frequency	50-60 Hz
Fréquence	
Velocità aria	
Air Speed	80 Km/h
Vitesse d'air	

Volume aria	
Air Flow	160 m ³ /h
Débit d'air	
Peso	
Weight	3 kg
Poids net	
Materiale	
Materials	ABS
Matériel	
Marchi di qualità	
Quality marks - certifications	CE
Certification	
Rumorosità (2 mt)	
Noise Level (2 mt)	60 db
Niveau sonore (2 mt)	
Garanzia	3 anni
Warranty	3 years
Garantie	3 ans

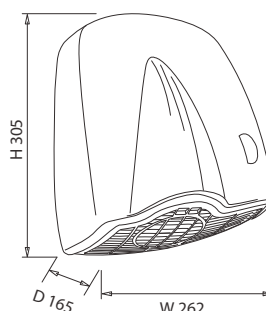

AEA - TURBOTIME - TURBOTRONIC

ASCIUGAMANI - HAND DRYERS - SÈCHE-MAINS

ASCIUGAMANI IN ABS - ABS HAND DRYERS - SÈCHE-MAINS EN ABS



GLI ASCIUGAMANI DI ALTA QUALITA' IN ABS DELLA TRADIZIONE VAMA

- Ideale per aree a traffico medio / ridotto
- Ottimo rapporto tra performance / consumi / budget di spesa
- Massima silenziosità: inferiore a 60 db
- Nessuna manutenzione, motore a induzione
- Elegante e pratico specchio in acciaio inox nelle versioni AEA

THE HIGH QUALITY ABS HAND DRYER: 100 % VAMA TRADITION

- The best for medium-low transit area
- The best balance between performance / electricity consumption / budget
- Noiseless: less than 60 db
- No need of maintenance, brushless motors
- Elegant and useful mirror (AEA models)

LES SÈCHE-MAINS DE HAUTE QUALITÉ TRADITIONNELS VAMA

- Idéal pour les zones de trafic (moyen / faible)
- Bonne relation entre performance / consommation / budget des dépenses
- Niveau de bruit maximum: moins de 60 db
- Pas d'entretien, moteur à induction
- Élégant et pratique miroir en acier inoxydable dans les versions AEA

M A D E I N I T A L Y



AEA - TURBOTIME - TURBOTRONIC

ASCIUGAMANI - HAND DRYERS - SÈCHE-MAINS

ASCIUGAMANI IN ABS - ABS HAND DRYERS - SÈCHE-MAINS EN ABS



AEA/87

1600 W, funzionante a pulsante
1600 W, push-button
1600 W, bouton poussoir



AEA/SUPER/87

2000 W, funzionante a pulsante
2000 W, push-button
2000 W, bouton poussoir



AEA/E/87

1600 W, funzionamento automatico
1600 W, sensor operating
1600 W, capteur



AEA/E/SUPER/87

2000 W, funzionamento automatico
2000 W, sensor operating
2000 W, capteur



TURBOTIME /98

1800 W, funzionante a pulsante
1800 W, push-button
1800 W, bouton poussoir



TURBOTRONIC/98

1800 W, funzionamento automatico
1800 W, sensor operating
1800 W, capteur

CARATTERISTICHE TECNICHE COMUNI COMMON TECHNICAL FEATURES CARACTÉRISTIQUES TECHNIQUES COMMUNES

Giri al minuto	
Tr min	2800 rpm
Révolutions par minute	
Grado di protezione elettrica	
Electrical Protection Level	IPX2 - CLASS II
Isolation électrique	
Tensione	
Supply Voltage	220 V-240 V
Tension d'alimentation	
Frequenza	
Frequency	50-60 Hz
Fréquence	
Velocità aria	
Air Speed	80 Km/h
Vitesse d'air	
Volume aria	
Air Flow	160 m ³ /h
Débit d'air	
Materiale	
Materials	ABS
Matériel	
Marchi di qualità	
Quality marks - certifications	CE
Certification	
Rumorosità (2 mt)	
Noise Level (2 mt)	60 db
Niveau sonore (2 mt)	
Garanzia	2 anni
Warranty	2 years
Garantie	2 ans

AEA - AEA/E

Caratteristica specifica / Specific features / Caractéristiques spécifiques

Dimensioni A x L x P	
Dimensions H x W x D	275 x 210 x 205 (mm)
Dimensioni H x L x P	
Peso	
Weight	2,6 kg
Poids net	
Potenza totale	
Total power	1600 W - 2000 W (super)
Puissance totale	

TURBOTIME - TURBOTRONIC

Caratteristica specifica / Specific features / Caractéristiques spécifiques

Dimensioni A x L x P	
Dimensions H x W x D	320 x 215 x 155 (mm)
Dimensioni H x L x P	
Peso	
Weight	3 kg
Poids net	
Potenza totale	
Total power	1800 W
Puissance totale	

AEA - AEA/E

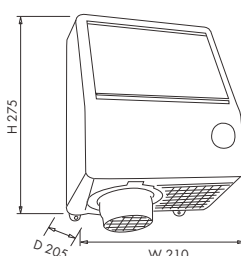

TURBOTIME TURBOTRONIC

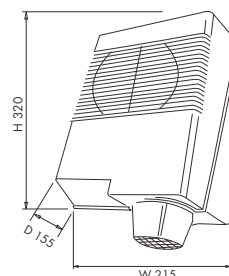

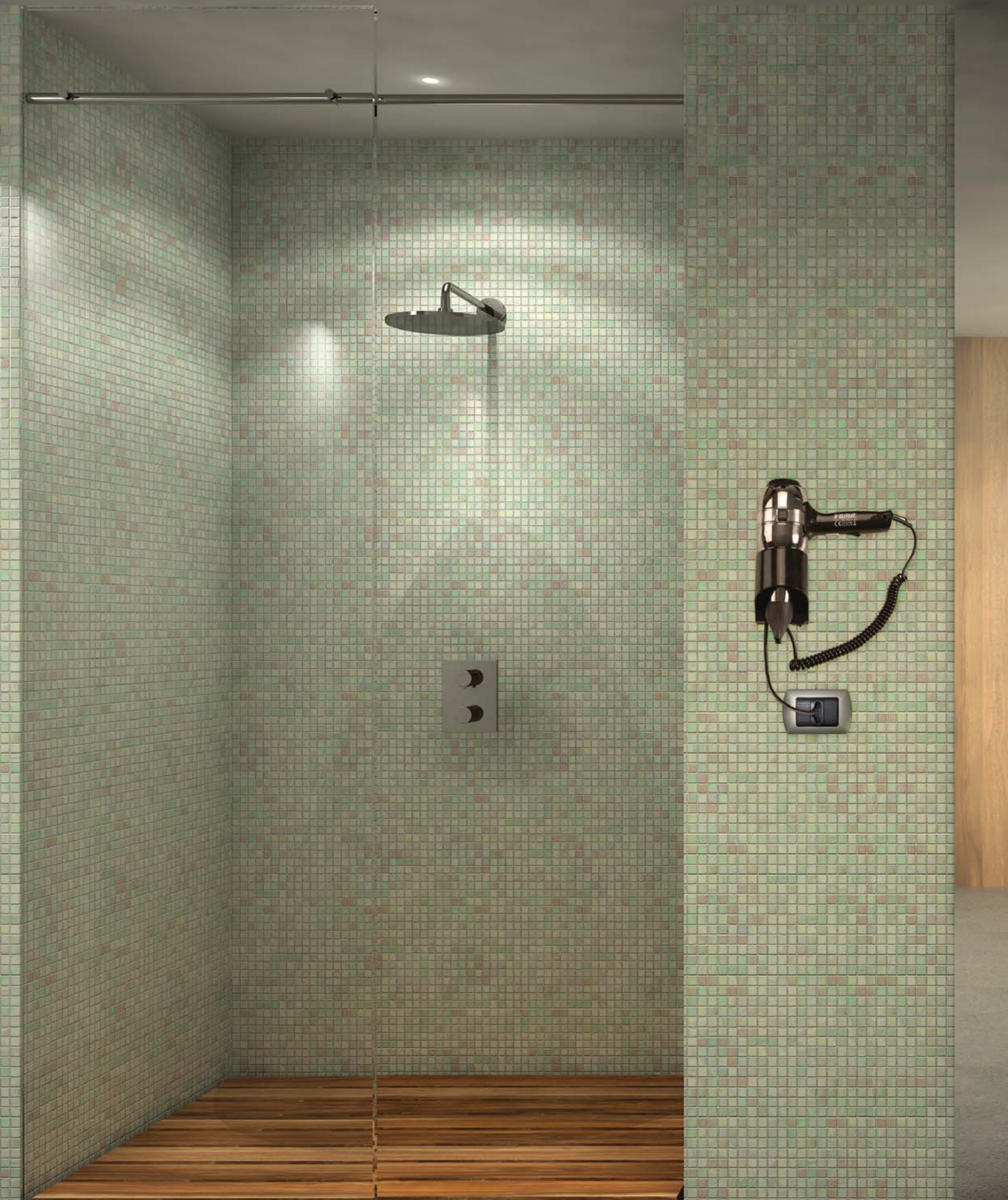





LINEA HOTEL
Hotel line - Ligne hotel

ASCIUGACAPELLI - HAIR DRYER - SÈCHE-CHEVEUX

COMFORT PRO
PLUG

-  - Asciugacapelli per hotel di fascia premium.
 - Corpo in ABS con eleganti finiture cromate.
 - 3 regolazioni di velocità aria / temperatura.
 - Pulsante a rilascio di sicurezza.
 - Termostato di sicurezza sulla resistenza.
 - Cavo spiralato flessibile di alimentazione, lunghezza 60/120 cm.
-  - Premium hotel hair dryer.
 - White ABS & elegant chrome finish.
 - 3 heat / speed settings.
 - Push-release button.
 - Overheating protection.
 - Flexible cable length 60/120 cm, with plug.
-  - Sèche-cheveux pour les équipements supérieurs de l'hotel.
 - Corps en ABS avec élégante finition chrome.
 - 3 réglages thermique / vitesse.
 - Bouton d'activation de sécurité a pression.
 - Thermostat de sécurité.
 - Cablage en spirale flexible 60/120 cm, avec prise bipolaire.



-  Sacchetto porta phon (opzionale)
-  Hair dryer bag (option)
-  Sac porte sèche cheveux (optionnel)



CARATTERISTICHE TECNICHE / TECHNICAL FEATURES / CARACTÉRISTIQUES TECHNIQUES

Funzionamento	Pulsante a rilascio di sicurezza
Functioning	Push / release button
Activation	Bouton-poussoir de sécurité
Grado di protezione elettrica	
Electrical Protection Level	CLASS II
Isolation électrique	
Tensione	
Supply Voltage	220 V - 240 V
Tension d'alimentation	
Potenza complessiva	3 regolazioni max. 1800 W
Power	3 settings max. 1800 W
Puissance	3 réglages max. 1800 W
Dimensioni A x L x P	
Dimensions H x W x D	220 x 205 x 81 (mm)
Dimensions H x L x P	
Frequenza	
Frequency	50-60 Hz
Fréquence	
Volume aria	
Air Flow	max. 26 l/s
Débit d'air	
Peso	
Weight	0,820 Kg
Poids net	

Materiale	
Materials	ABS
Matériel	
Marchi di qualità	
Quality marks - certifications	CE RoHs
Certification	
Garanzia	2 anni
Warranty	2 years
Garantie	2 ans

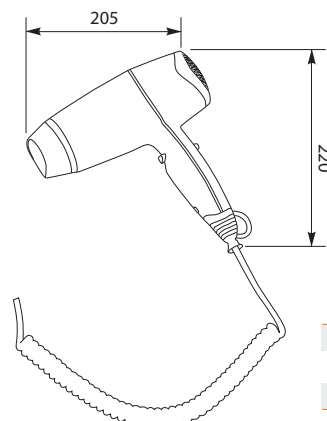

Profondità	
Depth	81 mm
Profondeur	

COMFORT PRO

-  - **Base a muro in ABS con elegante finitura cromata.**
 - Cavo spiralato flessibile tra l'asciugacapelli e la base a muro, lunghezza 60/120 cm.
 - Cavo lineare di alimentazione con spina bipolare dalla base a muro, lunghezza 90 cm.
 - Interruttore ON - OFF sulla base a muro.
-  - **ABS wall base with elegant chrome finish.**
 - Flexible cable between hair dryer/wall base, length 60/120 cm.
 - Linear supply cable with plug from wall base, length 90 cm.
 - ON - OFF safety switch button on wall-base.
-  - **Support mural en ABS avec élégante finition chrome.**
 - Cablage en spirale flexible entre sèche-cheveux et la base murale, longueur 60/120 cm.
 - Cable linéaire d'alimentation avec prise bipolaire, longueur 90 cm.
 - Interrupteur ON - OFF de sécurité sur la base murale.



CARATTERISTICHE TECNICHE / TECHNICAL FEATURES / CARACTÉRISTIQUES TECHNIQUES

Funzionamento	Pulsante a rilascio di sicurezza
Functioning	Push / release button
Activation	Bouton-poussoir de sécurité
Grado di protezione elettrica	
Electrical Protection Level	CLASS II
Isolation électrique	
Tensione	
Supply Voltage	220 V - 240 V
Tension d'alimentation	
Potenza complessiva	2 velocità max. 1800 W
Power	2 speeds max. 1800 W
Puissance	2 vitesses max. 1800 W
Dimensioni A x L x P	
Dimensions H x W x D	220 x 250 x 140 (mm)
Dimensions H x L x P	
Frequenza	
Frequency	50-60 Hz
Fréquence	
Volume aria	
Air Flow	max. 26 L/s
Débit d'air	
Peso	
Weight	0,850 Kg
Poids net	

Materiale	
Materials	ABS
Matériel	
Marchi di qualità	
Quality marks - certifications	CE RoHs
Certification	
Garanzia	2 anni
Warranty	2 years
Garantie	2 ans

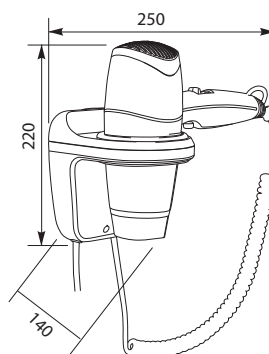





ASCIUGACAPELLI - HAIR DRYERS - SÈCHE - CHEVEUX

-  - Asciugacapelli per hotel di fascia premium.
- Corpo in ABS con eleganti finiture cromate.
- **Manico pieghevole per il minimo ingombro in larghezza.**
- 3 regolazioni di velocità aria / temperatura.
- Pulsante a rilascio di sicurezza.
- Termostato di sicurezza sulla resistenza.
- Cavo spiralato flessibile di alimentazione, lunghezza 60/120 cm.

-  - **Premium hotel hair dryer.**
- White ABS & elegant chrome finish.
- **Foldable handle.**
- 3 heat / speed settings.
- Push-release button.
- Overheating protection.
- Flexible cable length 60/120 cm, with plug.

-  - **Sèche-cheveux pour les équipements supérieurs de l'hotel.**
- Corps en ABS avec élégante finition chrome.
- **Poignée pliable pour largeur minimale.**
- 3 réglages thermique / vitesse.
- Bouton d'activation de sécurité à pression.
- Thermostat de sécurité.
- Cable a spirale 60/120 cm, avec prise bipolaire.



-  **Sacchetto porta phon (opzionale)**
-  **Hair dryer bag (option)**
-  **Sac porte sèche cheveux (optionnel)**



VIENTO SPACE
PLUG

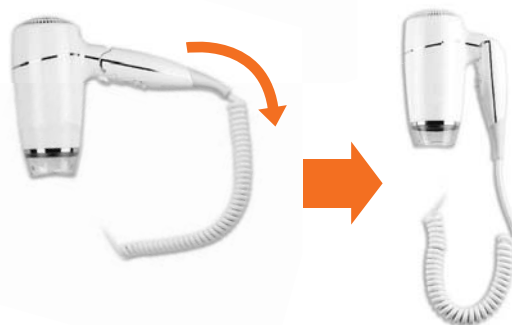

CARATTERISTICHE TECNICHE / TECHNICAL FEATURES / CARACTÉRISTIQUES TECHNIQUES

Funzionamento	Pulsante a rilascio di sicurezza
Functioning	Push / release button
Activation	Bouton-poussoir de sécurité
Grado di protezione elettrica	
Electrical Protection Level	CLASS II
Isolation électrique	
Tensione	
Supply Voltage	220 V - 240 V
Tension d'alimentation	
Potenza complessiva	3 velocità max. 1650 W
Power	3 speeds max. 1650 W
Puissance	3 vitesses max. 1650 W
Dimensioni A x L x P	
Dimensions H x W x D	190 x 270 (130) x 77 (mm)
Dimensions H x L x P	
Frequenza	
Frequency	50-60 Hz
Fréquence	
Volume aria	
Air Flow	max. 26 L/s
Débit d'air	
Peso	
Weight	0,760 Kg
Poids net	

Materiale	
Materials	ABS
Matériel	
Marchi di qualità	
Quality marks - certifications	CE RoHs
Certification	
Garanzia	2 anni
Warranty	2 years
Garantie	2 ans

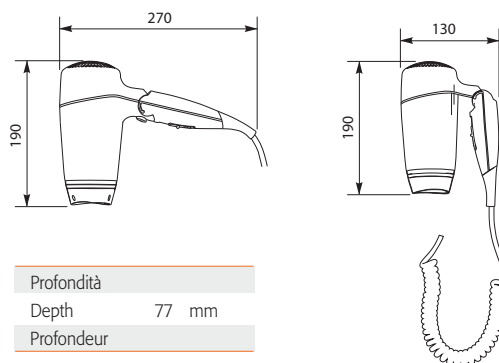

Profondità	
Depth	77 mm
Profondeur	

VIENTO SPACE

- Base a muro in ABS.
- **Manico pieghevole per il minimo ingombro in larghezza.**
- Interruttore on-off sulla base a muro.
- Cavo spiralato flessibile tra l'asciugacapelli e la base a muro, lunghezza 60/120 cm.
- Cavo lineare di alimentazione con spina bipolare dalla base a muro, lunghezza 90 cm.

- ABS wall base.
- **Foldable handle.**
- ON - OFF safety switch button on wall-base.
- Flexible cable between hair dryer/wall base, lenght 60/120 cm.
- Linear supply cable with plug from wall base, lenght 90 cm.

- Support mural en ABS.
- **Poignée pliable pour largeur minimale.**
- Interrupteur ON - OFF de sécurité sur la base murale.
- Cablage en spirale flexible entre sèche-cheveux et la base murale, longueur 60/120 cm.
- Cable linéaire d'alimentation avec prise bipolaire, longueur 90 cm.

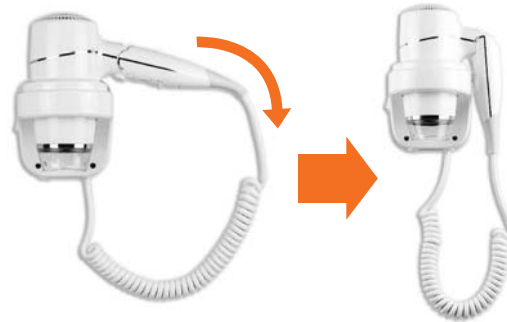

CARATTERISTICHE TECNICHE / TECHNICAL FEATURES / CARACTÉRISTIQUES TECHNIQUES

Funzionamento	Pulsante a rilascio di sicurezza
Functioning	Push / release button
Activation	Bouton-poussoir de sécurité
Grado di protezione elettrica	
Electrical Protection Level	CLASS II
Isolation électrique	
Tensione	
Supply Voltage	220 V - 240 V
Tension d'alimentation	
Potenza complessiva	2 velocità max. 1650 W
Power	2 speeds max. 1650 W
Puissance	2 vitesse max. 1650 W
Dimensioni A x L x P	
Dimensions H x W x D	190 x 270 (145) x 140 (mm)
Dimensions H x L x P	
Frequenza	
Frequency	50-60 Hz
Fréquence	
Volume aria	
Air Flow	max. 26 L/s
Débit d'air	
Peso	
Weight	0,780 Kg
Poids net	

Materiale	
Materials	ABS
Matériel	
Marchi di qualità	
Quality marks - certifications	CE RoHs
Certification	
Garanzia	2 anni
Warranty	2 years
Garantie	2 ans

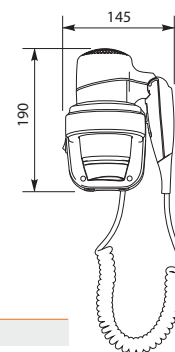
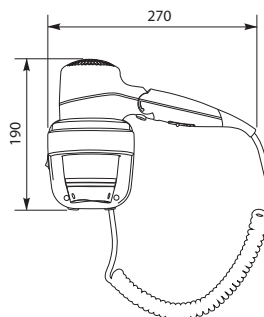



Profondità	
Depth	140 mm
Profondeur	

-  - Asciugacapelli per hotel di fascia premium.
 - Corpo in ABS con eleganti finiture cromate.
 - 3 regolazioni di velocità aria / temperatura.
 - Pulsante a rilascio di sicurezza.
 - Termostato di sicurezza sulla resistenza.
 - Cavo spiralato flessibile di alimentazione con spina bipolare lunghezza 60/120 cm.

-  - Premium hotel hair dryer.
 - White ABS and elegant chrome finishes.
 - 3 heat / speed settings.
 - Push-release button.
 - Overheating protection.
 - Flexible cable with plug, length 60/120 cm.

-  - Sèche-cheveux pour les équipements supérieurs de l'hotel.
 - Corps en ABS avec élégante finition chrome.
 - 3 réglage de la vitesse de l'air / température.
 - Bouton d'activation de sécurité a pression.
 - Thermostat de sécurité.
 - Cablage en spirale flexible avec prise bipolaire, longueur 60/120 cm.



-  Sacchetto porta phon (opzionale)
-  Hair dryer bag (option)
-  Sac porte sèche cheveux (optionnel)



CARATTERISTICHE TECNICHE / TECHNICAL FEATURES / CARACTÉRISTIQUES TECHNIQUES

Funzionamento	Pulsante a rilascio di sicurezza
Functioning	Push / release button
Activation	Bouton-poussoir de sécurité
Grado di protezione elettrica	
Electrical Protection Level	CLASS II - IP 21
Isolation électrique	
Tensione	
Supply Voltage	220 V - 240 V
Tension d'alimentation	
Potenza complessiva	3 regolazioni max. 1200 W
Power	3 settings max. 1200 W
Puissance	3 réglages max. 1200 W
Dimensioni A x L x P	
Dimensions H x W x D	215 x 160 x 75 (mm)
Dimensions H x L x P	
Frequenza	
Frequency	50-60 Hz
Fréquence	
Volume aria	
Air Flow	16,66 - 26,38 l/s (60 - 95 cbm/h)
Débit d'air	
Peso	
Weight	0,460 Kg
Poids net	

Materiale	
Materials	ABS
Matériel	
Marchi di qualità	
Quality marks - certifications	CE RoHS
Certification	
Garanzia	2 anni
Warranty	2 years
Garantie	2 ans
Termostato di sicurezza	
Safety Thermostat	
Thermostat de sécurité	

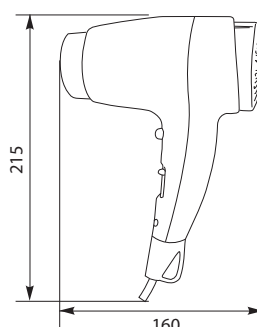

Profondità	
Depth	75 mm
Profondeur	

ELEGANT PRO

BASIC



- Base murale **Standard** in ABS bianco.
- White ABS **Standard** wall-base.
- Support mural **Standard** en ABS blanc.

Potenza complessiva	3 regolazioni max. 1500 W	
Power	3 settings max. 1500 W	
Puissance	3 réglages max. 1500 W	
Profondità	Peso	
Depth 140 mm	Weight	0,700 Kg
Profondeur	Poids net	

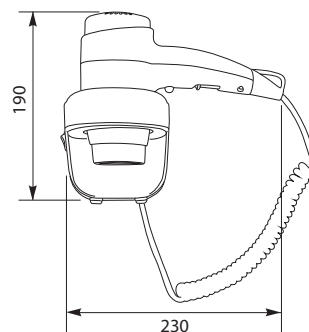

- Interruttore di sicurezza ON / OFF sulla base a muro
- ON - OFF safety switch button on wall-base
- ON - OFF Interrupteur de sécurité sur la base mural
- Cavo spiralato flessibile tra asciugacapelli / base a muro, lunghezza 60/120 cm
- Flexible cable between hair dryer / wall base, length 60/120 cm
- Cable a spirale entre support mural / sèche-cheveux, longueur 60/120 cm
- Cavo lineare di alimentazione con spina bipolare, lunghezza 90 cm
- Linear supply cable with plug, length 90 cm
- Cable linéaire d'alimentation avec prise bipolaire, longueur 90 cm

ELEGANT PRO

SHAVER



IP 21

- Base murale in ABS bianco, con presa rasoio 220/110 V. Livello di protezione **IP21**. Potenza max. **1500 W**.
- White ABS wall-base, with 220/110 V shaver socket. **IP21** ingress protection level. Power max. **1500 W**.
- Support mural en ABS blanc, avec prise rasoir bipolaire 220/110 V. Niveau de protection **IP21**. **Installation volume 3**. Isolation électrique Class II. Puissance **1500 W**.

Profondità	Peso	
Depth 105 mm	Weight	0,850 Kg
Profondeur	Poids net	

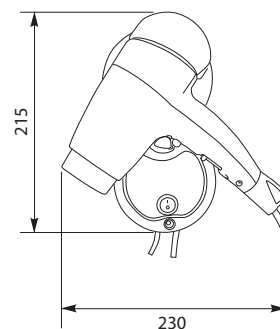

- Interruttore di sicurezza ON / OFF sulla base a muro
- ON - OFF safety switch button on wall-base
- ON - OFF Interrupteur de sécurité sur la base mural
- Presa rasoio
- Shaver socket 220/110 V
- Pris rasoir
- Cavo spiralato flessibile tra asciugacapelli / base a muro, lunghezza 60/120 cm
- Flexible cable between hair dryer / wall base, length 60/120 cm
- Cable a spirale entre support mural / sèche-cheveux, longueur 60/120 cm
- Cavo lineare di alimentazione con spina bipolare, lunghezza 90 cm
- Linear supply cable with plug, length 90 cm
- Cable linéaire d'alimentation avec prise bipolaire, longueur 90 cm



IP 21

ON/OFF

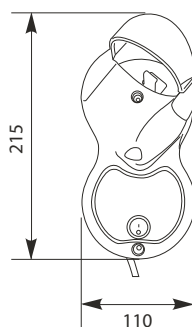

Profondità	Peso	
Depth 105 mm	Weight	0,850 Kg
Profondeur	Poids net	

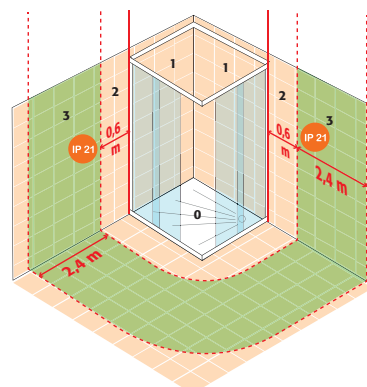

- ZONE D'INSTALLATION DE SÉCURITÉ VOLUME 3**
- Volume 3 = Area di sicurezza di installazione**
- Volume 3 = Safety installing area**

- Asciugacapelli e base a muro in ABS.
- 2 regolazioni di velocità aria / temperatura.
- Pulsante a rilascio di sicurezza.
- Interruttore on-off sulla base a muro e termostato di sicurezza.
- Cavo spiralato flessibile tra l'asciugacapelli e la base a muro, lunghezza 50 cm/120 cm.
- Cavo lineare di alimentazione con spina bipolare dalla base a muro, lunghezza 90 cm.

- ABS hair dryer with wall base.
- 2 heat / speed settings.
- Push-release button.
- ON - OFF safety switch button on wall-base. Overheating protection.
- Flexible cable between hair dryer/wall base, length 50 cm/120 cm.
- Linear supply cable with plug from wall base, length 90 cm.

- Le sèche-cheveux avec support mural en ABS.
- 2 réglages thermique / vitesse.
- Bouton d'activation de sécurité a pression.
- Interrupteur ON - OFF de sécurité sur la base murale.
- Cable a spirale entre le support mural et le sèche-cheveux, longueur 50 cm/120 cm.
- Cable linéaire d'alimentation avec prise bipolaire, longueur 90 cm.



CARATTERISTICHE TECNICHE / TECHNICAL FEATURES / CARACTÉRISTIQUES TECHNIQUES

Funzionamento	Pulsante a rilascio di sicurezza
Functioning	Push / release button
Activation	Bouton-poussoir de sécurité
Grado di protezione elettrica	
Electrical Protection Level	CLASS II
Isolation électrique	
Tensione	
Supply Voltage	220 V-240 V
Tension d'alimentation	
Potenza complessiva	2 velocità max. 1200 W
Power	2 speeds max. 1200 W
Puissance	2 vitesse max. 1200 W
Dimensioni A x L x P	
Dimensions H x W x D	150x91x147 (mm)
Dimensions H x L x P	
Frequenza	
Frequency	50-60 Hz
Fréquence	
Volume aria	
Air Flow	max.. 22,5 L/s
Débit d'air	
Peso	
Weight	0,650 Kg
Poids net	
Materiale	
Materials	ABS
Matériel	
Marchi di qualità	
Quality marks - certifications	CE RoHs
Certification	

Garanzia	2 anni
Warranty	2 years
Garantie	2 ans

Altre caratteristiche / Other features / Autres caractéristiques

Interruttore di sicurezza ON / OFF sulla base a muro
Termostato di sicurezza
Cavo estensibile
ON - OFF safety switch button on wall-base
Safety thermostat
Flexible cable
ON - OFF Interrupteur de sécurité sur la base mural
Thermostat de sécurité
Câble flexible

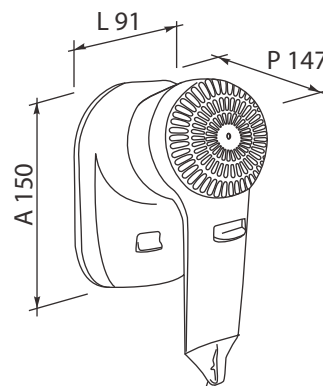

VIENTO 2



**STESSE CARATTERISTICHE VIENTO 1 ECCETTO:
SAME FEATURES AS VIENTO 1 EXCEPT:
MÊMES CARACTÉRISTIQUES VIENTO 1, À L'EXCEPTION:**

Dimensioni A x L	
Dimensions H x W	193 x 200 x 102 mm
Dimensions H x L	
Peso	
Weight	0,650 Kg
Poids net	
Profondità (dal muro)	
Depth (wall-mounted)	102 mm
Profondeur (mur)	

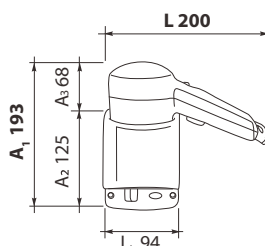

VIENTO SHAVER



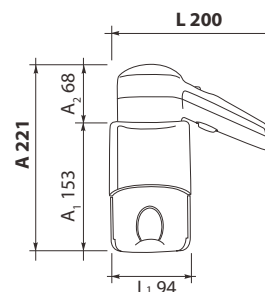

Dimensioni A x L	
Dimensions H x W	221 x 200 x 112 mm
Dimensions H x L	
Peso	
Weight	1,250 Kg
Poids net	
Profondità (dal muro)	
Depth (wall-mounted)	112 mm
Profondeur (mur)	
Preso rasoio	
Shaver socket	220 - 110 V
Pris rasoir	



**PRESA RASOIO BIPOLARE 220-110V
BIPOLAR 220-110V SHAVR SOCKET
PRIS RASOIR BIPOLAIRE 220-110V**

VIENTO SHAVER DA CASSETTO



 MURALE O DA CASSETTO
 WALL BASE OR DRAWER MODEL
 MODEL MURAL OU POUR TIROIR



Dimensioni A x L	
Dimensions H x W	204 x 182 mm
Dimensions H x L	
Peso	
Weight	0,850 Kg
Poids net	
Profondità (dal muro)/Altezza (cassetto)	
Depth (wall-mounted)/Height (drawer)	90 mm
Profondeur (mur)/Hautesse (tiroir)	
Preso rasoio	
Shaver socket	220 - 110 V
Pris rasoir	

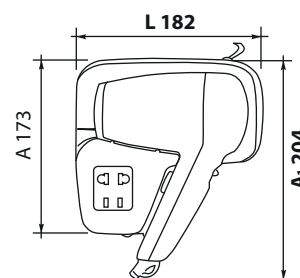

**PRESA RASOIO BIPOLARE 220-110V
BIPOLAR 220-110V SHAVR SOCKET
PRIS RASOIR BIPOLAIRE 220-110V**

ASCIUGACAPELLI- HAIR DRYERS- SÈCHE-CHEVEUX

STESSE CARATTERISTICHE VIENTO 1 ECCETTO:
 SAME FEATURES AS VIENTO 1 EXCEPT:
 MÊMES CARACTÉRISTIQUES VIENTO 1, À L'EXCEPTION:

Dimensioni A x L	
Dimensions H x L	204 x 182 mm
Dimensions H x L	
Peso	
Weight	0,850 Kg
Poids net	
Profondità (dal muro)/Altezza (cassetto)	
Depth (wall-mounted)/Height (drawer)	90 mm
Profondeur (mur)/Hautesse (tiroir)	
Interruttore differenziale salvavita con autodiagnosi	
Life saving system auto turn-off	
Interrupteur de sécurité coupe - circuit sur la base	

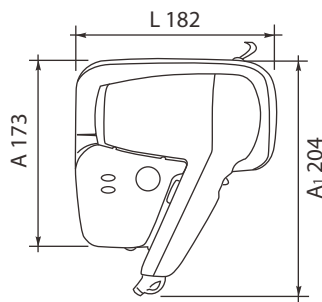

-  MURALE O DA CASSETTO
-  WALL BASE OR DRAWER MODEL
-  MODEL MURAL OU POUR TIROIR

**INTERRUTTORE DIFFERENZIALE SALVAVITA
 CON AUTODIAGNOSI**
LIFE SAVING SYSTEM AUTO TURN-OFF
**INTERRUPTEUR DE SÉCURITÉ COUPE -
 CIRCUIT SUR LA BASE**

Dimensioni A x L x P	
Dimensions H x W x D	182x 138 x 77 mm
Dimensions H x L x P	
Peso	
Weight	0,3 Kg
Poids net	

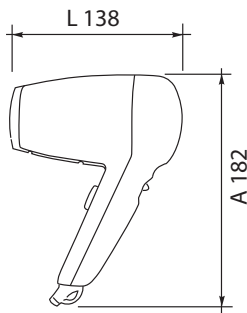

VIENTO PLUG

-  MODELLO DA CASSETTO
-  DRAWER MODEL
-  MODEL POUR TIROIR

CAVO SPIRALATO 60 CM CON SPINA
60 CM FLEXIBLE CABLE WITH PLUG
CÂBLE FLEXIBLE 60 CM. AVEC PRISE

-  SACCHETTO PORTA PHON (OPZIONALE)
-  HAIR DRYER BAG (OPTION)
-  SAC PORTE SÈCHE CHEVEUX (OPTIONNEL)





Sacchetto Porta phon in poliestere,

dimensioni:
 Altezza: 30 cm
 Lunghezza: 27 cm

ASCIUGACAPELLI - HAIR DRYERS - SÈCHE-CHEVEUX

-  - **Motore a corrente alternata professionale**
 - 2 regolazioni separate di velocità aria e 3 di temperatura
 - Attivazione con tasto on-off
 - Tasto per colpo di aria fredda istantanea
 - Potenza max. 1800 W
 - Termostato sulla resistenza
 - Disponibile in ABS colore nero
 - **Cavo spiralato 0,5 mt. + cavo lineare 1,00 mt. con spina bipolare Italia**
 - Disponibile con supporto murale universale in ABS nero (opzionale)
-  - **Powerful professional AC motor**
 - 3 heat / 2 speed separate settings
 - Cool shot button
 - Max. power 1800 W
 - Black ABS
 - **Cable length 0,5 mt. (coiled) + 1,00 mt. (linear), with plug**
 - Option: black ABS wall base, suitable for heavy traffic
-  - **Moteur AC professionnel longue durée de vie**
 - 3 réglages thermique / 2 réglages de vitesse séparé
 - Bouton pour coup froid
 - Max. puissance 1800 W
 - ABS noir
 - **Longueur de câble jusqu'à 0,5 mt. (spirale) + 1,00 mt. (linéaire), avec prise bipolaire**
 - Optionnel: support mural en ABS noir, idéal pour usage intensif



-  * Per le limitazioni di garanzia si vedano le condizioni generali di servizio
-  * Limited warranty. Please have a look to the General Warranty Conditions for details and consumables
-  * Limitations de garantie: en revoir Conditions de Garantie Generale



CARATTERISTICHE TECNICHE TECHNICAL FEATURES / CARACTÉRISTIQUES TECHNIQUES

Funzionamento	Tasto ON/OFF
Functioning	ON/OFF switch
Activation	Bouton ON/OFF
Grado di protezione elettrica	
Electrical Protection Level	CLASS II
Isolation électrique	
Tensione	
Supply Voltage	220 V-240 V
Tension d'alimentation	
Potenza complessiva	max. 1800 W
Power	max. 1800 W
Puissance	max. 1800 W
Frequenza	
Frequency	50-60 Hz
Fréquence	
Volume aria	
Air Flow	max. 30,0 L/s
Débit d'air	
Peso	
Weight	0,520 Kg
Poids net	
Materiale	
Materials	ABS
Matériel	
Marchi di qualità	
Quality marks - certifications	CE RoHS
Certification	

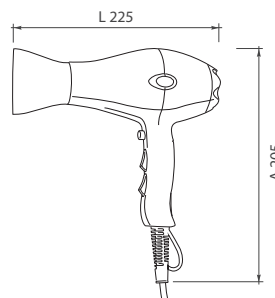

Dimensioni A x L x P	
Dimensions H x W x D	205 x 225 x 91 (mm)
Dimensions H x L x P	

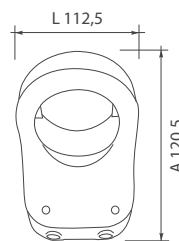

Dimensioni A x L x P	
Dimensions H x W x D	120,5 x 112,5 x 142,5 (Ø 64) mm
Dimensions H x L x P	
Peso	
Weight	0,175 Kg
Poids net	



ETERNITY
CLASSIC



ETERNITY
PLUG



ETERNITY
SHAVER



PROFESSIONALE NELLE PRESTAZIONI E NEL RISPARMIO ENERGETICO

Motore a corrente alternata professionale. 2 regolazioni per velocità aria / temperatura. Potenza max. da 1300 W o 1800 W (solo versione "Classic"). Versione bianca a 1600 W. Uscita d'aria con concentratore professionale. Filtro rimovibile.

IL MASSIMO DELLA SICUREZZA: attivazione con pulsante a pressione, spegnimento a rilascio, termostato sulla resistenza, interruttore on-off sulla base a muro.

CLASSE & ELEGANZA: Acciaio / ABS colore nero. Design vintage.

VERSATILITÀ: 3 versioni: con base a muro standard; con base a muro con presa rasoio; senza base a muro e con cavo lineare e spina.

PROFESSIONAL & ENERGY SAVING HOTEL HAIR DRYER

Powerful professional AC motor. 2 heat / speed settings. Max power 1300 W or 1800 W ("Classic" version only) Version in white 1600 W. Concentrator. Removable filter for cleaning.

HIGH SAFETY LEVEL: push button operating. Overheating protection. Wall-base ON-OFF switch.

FIRST CLASS: stainless steel & ABS. Vintage design.

FLEXIBILITY: available with standard wall-base; with shaver socket wall-base; without wall base and with linear cable.

LE SÈCHE-CHEVEUX PROFESSIONNEL AVEC DES GRANDS ECONOMIE D'ENERGIE

Moteur AC professionnel longue durée de vie. 2 réglages thermique / vitesse. Puissance max 1300 W ou 1800 W Version au 1600 W. Concentrateur. Filtre amovible pour le nettoyage.

SÉCURITÉ MAXIMAL BOUTON PRESSION: Thermostat de sécurité. Interrupteur ON-OFF sur le support mural.

ELEGANCE: acier ABS couleur noir.

VERSATILITÉ: disponible avec le support mural standard, avec une prise de rasoir, avec le cable linéaire.

* Per le limitazioni di garanzia si vedano le condizioni generali di servizio

* Limited warranty. Please have a look to the General Warranty Conditions for details and consumables

* Limitations de garantie: en revoir Conditions de Garantie Generale

ASCIUGACAPELLI - HAIR DRYERS - SÈCHE-CHEVEUX

ETERNITY CLASSIC

Base a muro e particolari in ABS nero. Cavo a spirale tra la base a muro e il phon. Cavo di alimentazione lineare (1 mt.) con spina bipolare. Disponibile nella versione 1300 W o 1800 W

ETERNITY SHAVER

Base a muro e particolari in ABS nero con presa rasoio 230 / 110 V. Base e particolari bianchi nella versione "Shaver" 1600 W con presa rasoio monotensione 230 V. Cavo a spirale tra la base e il phon. Cavo di alimentazione lineare (1 mt.) con spina bipolare.

ETERNITY PLUG

Cavo lineare fino a 3 mt. con spina bipolare.
(raccomandato per installazioni in palestre e spogliatoi)

ETERNITY CLASSIC

ABS wall base, black colour. Available in 1300 W or 1800 W. Coiled cable between wall base and hair dryer. Linear power supply cable (1 mt.) with plug.

ETERNITY SHAVER

ABS wall base with 230 / 110 V shaver socket, black colour. White version with 1600 W power and 230 V shaver socket only. Coiled cable between wall base and hair dryer. Linear power supply cable (1 mt.) with plug.

ETERNITY PLUG

Linear cable up to 3 mt. with plug.
(recommended for sport centers and changing rooms)

ETERNITY CLASSIC

Support mural en abs noir. Cable a spirale entre le support mural. Disponible en 1300 W on 1800 W. et le sèche-cheveux. Cable linéaire d'alimentation (1 mt.) avec prise bipolaire.

ETERNITY SHAVER

Support mural en abs noir avec prise rasoir 230 / 110 V. Support et détails blanc pour 1600 W avec pris rasoir 230 V. Cable a spirale entre le support mural et le sèche-cheveux. Cable linéaire d'alimentation (1 mt.) avec prise bipolaire.

ETERNITY PLUG

Cable linéaire jusqu'à 3 mètres avec prise bipolaire.
(recommandé pour l'installation dans les gymnases et les vestiaires)

CARATTERISTICHE TECNICHE TECHNICAL FEATURES / CARACTÉRISTIQUES TECHNIQUES

Funzionamento	Pulsante a rilascio
Functioning	Push / release button
Activation	Bouton-poussoir
Grado di protezione elettrica	
Electrical Protection Level	CLASS II
Isolation électrique	
Tensione	
Supply Voltage	220 V - 240 V
Tension d'alimentation	
Potenza complessiva	1300 W o 1800 W / 1600 W SHAVER BIANCO
Power	1300 W or 1800 W / 1600 W WHITE SHAVER
Puissance	1300 W ou 1800 W / 1600 W BLANC SHAVER
Dimensioni A x L x P	218 x 260 x 90 (mm) PLUG
Dimensions H x W x D	250 x 228 x 155 (mm) SHAVER
Dimensions H x L x P	260 x 218 x 110 (mm) CLASSIC
Frequenza	
Frequency	50-60 Hz
Fréquence	
Volume aria	
Air flow	max. 30,0 L/s
Débit d'air	
Peso	
Weight	0,800 Kg
Poids net	
Materiale	Acciaio / ABS
Materials	Stainless steel / ABS
Matériel	Acier / ABS
Marchi di qualità	
Quality marks - certifications	CE RoHs
Certification	

ETERNITY SHAVER

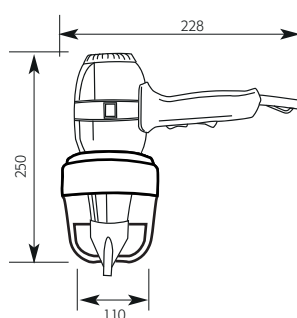

Profondità	
Depth	155 mm
Profondeur	

ETERNITY CLASSIC

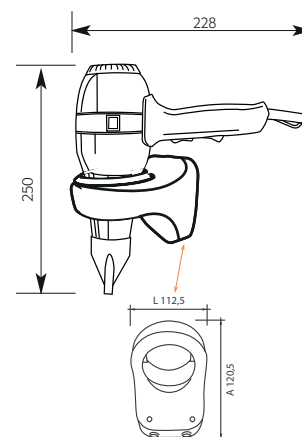

Profondità	142,5 mm
------------	----------

ETERNITY PLUG

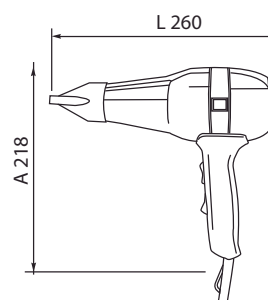

Profondità	
Depth	90 mm
Profondeur	



FIT PHON
BIANCO

FIT PHON
NERO

**ANELLO PER FISSAGGIO A MURO
CON BLOCCA CAVO
WALL MOUNTING RING
WITH CABLE LOCK
BAGUE POUR MONTAGE MURAL**



L'ECCELLENZA DELLA PERFORMANCE: motore a corrente alternata professionale.

Regolazioni multiple combinabili: 2 per velocità aria, 3 per temperatura.

Potenza standard max. 1800 W (USO HOTEL)

Disponibile anche nella versione a risparmio energetico max. 1000 W (USO COMUNITARIO)

Filtro rimovibile.

IL MASSIMO DELLA SICUREZZA: attivazione con pulsante a pressione, spegnimento a rilascio, termostato sulla resistenza.

L'ELEGANZA: disponibile in 2 versioni, ABS colore bianco e ABS nero.

Design ergonomico e contemporaneo.

Disponibile con supporto a muro in ottone cromato (opzionale).

LA PRATICITÀ: grande comodità d'uso grazie al cavo spiralato 0,5 mt. + cavo lineare 1,5 mt.

DIFFUSORE PROFESSIONALE INCLUSO



HIGH PERFORMANCE: powerful professional AC motor.

3 heat and 2 speed settings.

Standard max. power 1800 W (HOTEL ONLY)

Available also in 1000 W version (LOCKER ROOM)

Removable filter for cleaning.

HIGH SAFETY LEVEL: push button operating. Overheating protection.

ELEGANT: available in white & black colour. Ergonomic & contemporary design.

Available with chrome brass holder (wall mounted).

EASY TO USE: Cable length 0,5 mt. (coiled) + 1,5 mt. (linear).

PROFESSIONAL CONCENTRATOR INCLUDED



EXCELLENCE DE LA PERFORMANCE: moteur AC professionnel longue durée de vie.

3 réglages thermique et 2 réglages de vitesse.

Puissance standard max 1800 W (HOTEL)

Aussi disponible en la version 1000 W (VESTIAIRE)

Filtre amovible pour le nettoyage.

SÉCURITÉ MAXIMALE: bouton pression, thermostat de sécurité.

ELEGANT: ABS blanc ou noir. Disponible avec le bague pour montage mural.

FACILE À UTILISER: longueur de câble jusqu'à 0,5 mt. (spirale) + 1,5 mt. (linéaire).

CONCENTRATEUR PROFESSIONNEL INCLUS







* Per le limitazioni di garanzia si vedano le condizioni generali di servizio

* Limited warranty. Please have a look to the General Warranty Conditions for details and consumables



* Limitations de garantie: en revoir Conditions de Garantie Generale

ASCIUGACAPELLI - HAIR DRYERS - SÈCHE-CHEVEUX



Cod.	Materiale Materials Matériel	Regolazioni velocità Speed settings Réglages de vitesse	Regolazioni temp. Heat settings Réglages thermique	Destinazione d'uso / supporto Recommended usage & wall base Utilisation recommandée / support
FT PHON BIANCO 1800W	ABS Bianco / White / Blanc	2	3	HOTEL 
FT PHON NERO 1800W	ABS nero / black / noir	2	3	
FT PHON BIANCO 1000W	ABS Bianco / White / Blanc	2	2	SPOGLIATOIO LOCKER ROOM VESTIAIRE 
FT PHON NERO 1000W	ABS nero / black / noir	2	2	

-  Cavo a spirale 0,5 mt. + cavo lineare 1,5 mt. con spina bipolare.
-  Cable length 0,5 mt. (coiled) + 1,5 mt (linear) with plug.
-  Longueur de cable 0,5 mt. (spirale) + 1,5 mt. (linéaire) avec prise bipolaire.



-  **SUPPORTO AD ANELLO PER FISSAGGIO A MURO (OPZIONALE)**
Supporto murale in ottone cromato, con blocca cavo all'interno del supporto, **ideale in hotel.**
-  **CHROME BRASS HOLDER (OPZIONALE)**
Ready for wall mounting with inside cable locking, **recommended for hotel.**
-  **SUPPORT MURAL PUR LE SÈCHE-CHEVEUX (OPTIONNEL)**
Support mural chromé, avec fixage antivol du cable, **pour hotel.**



-  **SUPPORTO PHON UNIVERSALE (OPZIONALE)**
Base murale in ABS nero, con blocca cavo all'interno del supporto, **ideale per uso comunitario.**
-  **BLACK ABS WALL BASE (OPTION)**
Cable Locking inside, **recommended for heavy traffic.**
-  **SUPPORT MURAL EN ABS (OPTIONNEL)**
Support mural en ABS noir, avec fixage antivol du cable, **pour usage intensif.**



CARATTERISTICHE TECNICHE TECHNICAL FEATURES / CARACTÉRISTIQUES TECHNIQUES

Funzionamento	Pulsante a rilascio
Functioning	Push / release button
Activation	Bouton-poussoir
Grado di protezione elettrica	
Electrical Protection Level	CLASS II
Isolation électrique	
Tensione	
Supply Voltage	220 V-240 V
Tension d'alimentation	
Potenza	1800 W (3 regolaz.) - 1000 W (2 regolaz.)
Power	1800 W (3 settings) - 1000 W (2 settings)
Puissance	1800 W (3 réglages) - 1000 W (2 réglages)
Frequenza	
Frequency	50-60 Hz
Fréquence	
Volume aria	
Air Flow	max. 30,0 L/s
Débit d'air	
Peso	
Weight	0,900 Kg
Poids net	
Materiale	
Materials	ABS
Matériel	
Marchi di qualità	
Quality marks - certifications	CE RoHs
Certification	
Garanzia	2 anni
Warranty	2 years
Garantie	2 ans

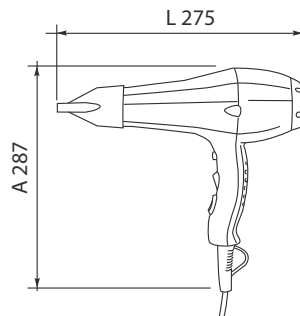

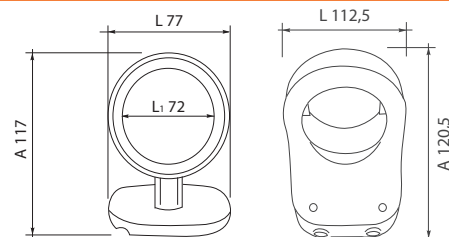

Dimensioni A x L x P	
Dimensions H x W x D	287 x 275 x 95 (mm)
Dimensions H x L x P	



Profondità (dal muro)		
Depth (wall-mounted)	118 mm	142,5 mm
Profondeur (mur)		
Dimensioni A x L		
Dimensions H x W	117 x 77 (Ø 72) mm	120,5 x 112,5 (Ø 64) mm
Dimensions H x L		
Peso		
Weight	0,165 Kg	0,175 Kg
Poids net		

ASCIUGACAPELLI - HAIR DRYERS - SÈCHE-CHEVEUX

**IL PIÙ PICCOLO PHON CON TUBO ESISTENTE!
THE SMALLEST EXISTING HAIR DRYER WITH HOSE!
LE PLUS PETIT SÈCHE CHEVEUX AVEC TUBE!**

-  - Asciugacapelli a parete in ABS con tubo flessibile e presa rasoio laterale 220 V – 110 V
 - **Motore a corrente alternata professionale**
 - 2 regolazioni di velocità aria / temperatura, max. 700 W
 - Attivazione automatica quando si sgancia il tubo
 - Autospegnimento dopo 5 min. in caso di mancato riaggancio del tubo
 - Termostato di sicurezza
-  - Wall mounted ABS hair dryer with flexible hose and shaver socket 220 V – 110 V
 - **Professional AC motor**
 - 2 heat / speed settings, max. 700 W
 - Auto turn-on when hose is released
 - Auto turn off after 5 min.
 - Overheating protection.
-  - Sèche-cheveux mural en ABS avec tube extensible et prise de rasoir 220V - 110V
 - **Moteur AC professionnel**
 - 2 vitesses, max. 700 W
 - Arrêt automatique (auto-timer): au bout de 5 minutes en cas de non repositionnement du tube
 - Thermostat de sécurité



CARATTERISTICHE TECNICHE / TECHNICAL FEATURES / CARACTÉRISTIQUES TECHNIQUES

Funzionamento	Allo sganciamento del tubo	Garanzia	2 anni
Functioning	Auto turn-on when hose is released	Warranty	2 years
Activation	Automatique a la poigné	Garantie	2 ans
Grado di protezione elettrica			
Electrical Protection Level	CLASS II		
Isolation électrique			
Tensione			
Supply Voltage	220 V-240 V		
Tension d'alimentation			
Potenza 2 velocità			
Power 2 Speeds	400W, 700W		
Puissance 2 Vitesse			
Dimensioni A x L x P	177(517 con tubo)x140x93 mm		
Dimensions H x W x D	177(517 with hose)x140x93 mm		
Dimensions H x L x P	177(517 avec tube)x140x93 mm		
Frequenza			
Frequency	50-60 Hz		
Fréquence			
Volume aria			
Air Flow	max. 30,0 L/s		
Débit d'air			
Peso			
Weight	0,98 Kg		
Poids net			
Materiale			
Materials	ABS		
Matériel			
Marchi di qualità			
Quality marks - certifications	CE RoHs		
Certification			

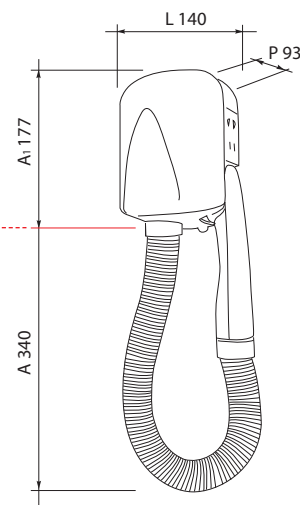



**ALTEZZA DAL SUOLO: 1,55 MT.
FLOOR HEIGHT: 1,55 MT.
POSITIONNEMENT À 1,55 MT. DU SOL**

 * Per le limitazioni di garanzia si vedano le condizioni generali di servizio

 * Limited warranty. Please have a look to the General Warranty Conditions for details and consumables

 * Limitations de garantie: en revoir Conditions de Garantie Generale

ASCIUGACAPELLI - HAIR DRYERS - SÈCHE-CHEVEUX

-  - Asciugacapelli a parete in ABS con tubo flessibile e presa rasoio frontale 220 V
 - 3 regolazioni di velocità aria / temperatura, max. 900 W
 - Attivazione automatica quando si sgancia il tubo
 - Autospegnimento dopo 10 min. in caso di mancato riaggancio del tubo
 - Termostato di sicurezza
 - **NO USO COLLETTIVO**
-  - Wall mounted ABS hair dryer with flexible hose and shaver socket 220 V
 - 3 heat / speed settings, max. 900 W
 - Auto turn-on when hose is released
 - Auto turn off after 10 min.
 - Overheating protection.
 - **NO HEAVY TRAFFIC**
-  - Sèche-cheveux mural en ABS avec tube extensible et prise de rasoir 220V
 - 3 vitesses, max. 900 W
 - Arrêt automatique (auto-timer): au bout de 10 minutes en cas de non repositionnement du tube
 - Thermostat de sécurité
 - **NO PASSAGE ÉLÉVÉE**



CARATTERISTICHE TECNICHE / TECHNICAL FEATURES / CARACTÉRISTIQUES TECHNIQUES

Funzionamento	Allo sganciamento del tubo	Garanzia	2 anni
Functioning	Auto turn-on when hose is released	Warranty	2 years
Activation	Automatique a la poigné	Garantie	2 ans
Grado di protezione elettrica			
Electrical Protection Level	CLASS II		
Isolation électrique			
Tensione			
Supply Voltage	220 V-240 V		
Tension d'alimentation			
Potenza 3 velocità			
Power 3 Speeds	400W, 700W, 900W		
Puissance 3 Vitesse			
Dimensioni A x L x P	250(590 con tubo)x184x117 mm		
Dimensions H x W x D	250(590 with hose)x184x117 mm		
Dimensions H x L x P	250(590 avec tube)x184x117 mm		
Frequenza			
Frequency	50-60 Hz		
Fréquence			
Volume aria			
Air Flow	max. 18,0 L/s		
Débit d'air			
Peso			
Weight	1,730 Kg		
Poids net			
Materiale			
Materials	ABS		
Matériel			
Marchi di qualità			
Quality marks - certifications	CE RoHs		
Certification			

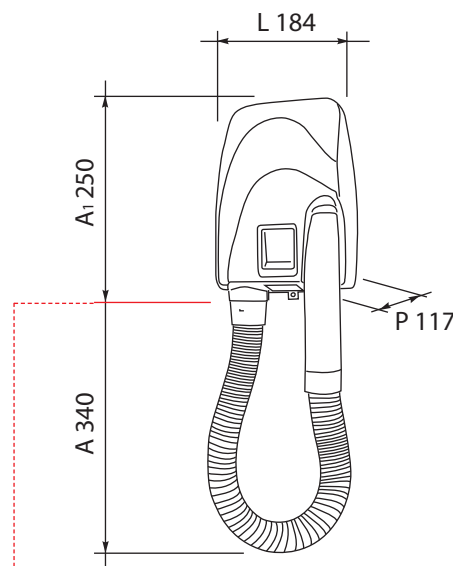

ALTEZZA DAL SUOLO: 1,55 MT.

FLOOR HEIGHT: 1,55 MT.

POSITIONNEMENT À 1,55 MT. DU SOL

 * Per le limitazioni di garanzia si vedano le condizioni generali di servizio

 * Limited warranty. Please have a look to the General Warranty Conditions for details and consumables

 * Limitations de garantie: en voir Conditions de Garantie Generale

MINIBAR LINEA HOTEL



MINIBAR

LINEA HOTEL - HOTEL LINE - LIGNE HOTEL

- Gamma completa di **minibar ad elevata efficienza energetica**, la soluzione perfetta per ottenere **silenziosità assoluta** al minimo consumo energetico possibile.
- Energy efficient hotel minibar ful range**: the most eco-friendly solution which grants **absolute quietness** and an extremely low energy consumption.
- Gamme complète de **minibars écoénergétiques**, la solution la plus écologique qui garantit un **silence absolu** et une consommation d'énergie extrêmement faible.

TOP A+ 28 Lt. GLASS



- Consumo giornaliero: **0,285 kWh**
- Daily consumption: **0,285 kWh**
- Consommation absorbée: **0,285 kWh**

- Consumo annuo: **98 kWh**
- Annual consumption: **98 kWh**
- Consommation absorbée: **98 kWh**

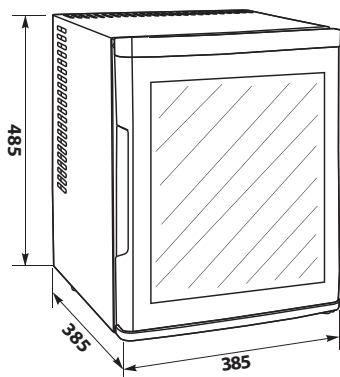

MINIBAR

LINEA HOTEL - HOTEL LINE - LIGNE HOTEL

TOP A+ 40 Lt.



- Consumo giornaliero: 0,269 kWh
- Daily consumption: 0,269 kWh
- Consommation absorbée: 0,269 kWh

- Consumo annuo: 99 kWh
- Annual consumption: 99 kWh
- Consommation absorbée: 99 kWh

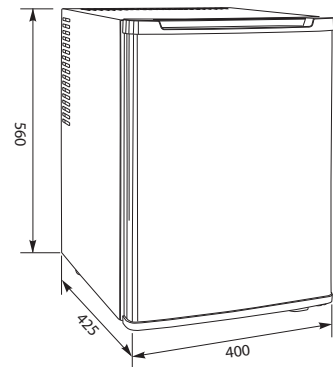

TOP A+ 30 Lt.

- Consumo giornaliero: 0,266 kWh
- Daily consumption: 0,266 kWh
- Consommation absorbée: 0,266 kWh

- Consumo annuo: 97 kWh
- Annual consumption: 97 kWh
- Consommation absorbée: 97 kWh

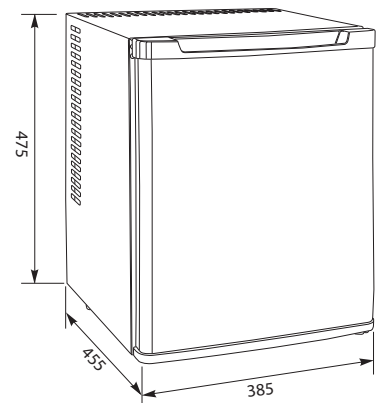

MINIBAR

LINEA HOTEL - HOTEL LINE - LIGNE HOTEL

TOP A+ 28 Lt.



Consumo giornaliero: 0,285 kWh
Daily consumption: 0,285 kWh
Consommation absorbée: 0,285 kWh

Consumo annuo: 104 kWh
Annual consumption: 104 kWh
Consommation absorbée: 104 kWh

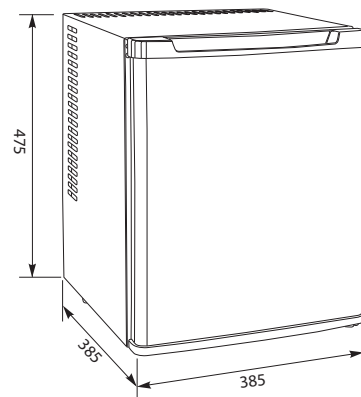

TOP A+ 20 LT.

Consumo giornaliero: 0,284 kWh
Daily consumption: 0,284 kWh
Consommation absorbée: 0,284 kWh

Consumo annuo: 104 kWh
Annual consumption: 104 kWh
Consommation absorbée: 104 kWh

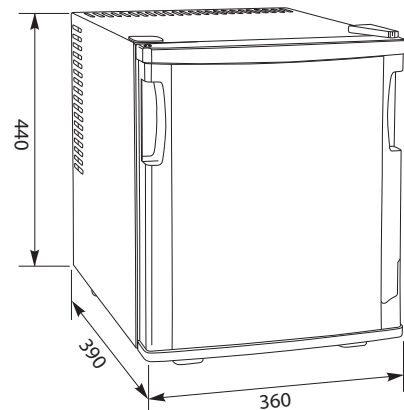

 **I minibar TOP A+ utilizzano un innovativo sistema di raffreddamento termoelettrico con cella di Peltier**, ossia una pompa di calore in grado di produrre in modo più efficiente l'effetto refrigerante dei minibar a compressore e assorbimento. Le maggiori caratteristiche dei minibar TOP A+ sono:

- Funzionamento **silenzioso e assenza di vibrazioni** (circuito di raffreddamento allo stato solido)
- Funzionamento con **qualsiasi inclinazione** (adatto quindi anche a navi da crociera)
- Sistema refrigerante **eco-friendly** e a basso impatto ambientale, senza uso di ammoniacca
- Consumo energetico di gran lunga inferiore a qualsiasi sistema di assorbimento, **con un risparmio del 60%/anno rispetto ai prodotti di classe energetica inferiore**

 **TOP A + minibars use an innovative thermoelectric cooling system based on the Peltier cell**, a heating pump performing the same function as compression or absorption refrigeration systems, but more efficiently. TOP A+ main features are:

- **Working noiselessly and without vibrations** (solid state device);
- **Operating in any gradient** (suitable also for cruise ships);
- It is the unique **environmentally friendly** cooling system;
- **Energy consumption 60% lower than absorption systems.**

 **Les minibars TOP A + utilisent un système de refroidissement thermoélectrique innovant avec cellule Peltier**, c'est-à-dire une pompe à chaleur capable de produire plus efficacement l'effet de refroidissement du compresseur et des minibars à absorption. Les principales caractéristiques des minibars TOP A + sont:

- **Fonctionnement silencieux et absence de vibration** (circuit de refroidissement à l'état solide)
- Fonctionnement avec **n'importe quelle inclinaison** (convient donc également aux bateaux de croisière)
- Système de refroidissement **écologique** et à faible impact environnemental, sans utilisation d'ammoniac
- Consommation d'énergie bien inférieure à tout système d'absorption, **avec une économie de 60% par an par rapport aux produits de classe énergétique inférieure**

CARATTERISTICHE / FEATURES / CARACTÉRISTIQUES

-  - Da incasso o libera installazione
- Termostato elettronico
 - Sbrinatorio automatico
 - Luce interna a LED basso consumo
 - Porta reversibile
 - Contiene bottiglie da 1 lt. e 1,5 lt. *
 - Gancio traino porta **
 - Refrigerante R600a

-  - Built-in / free standing
- Electronic thermostat
 - Electronic autodefrost
 - Low consumption LED inside
 - Reversible door
 - Suitable for 1lt. and 1,5 lt. bottles *
 - Sliding hinge fixture
 - R600a cooler

-  - Installation encastrée ou libre
- Thermostat électronique
 - Dégivrage automatique
 - Éclairage intérieur à LED
 - Porte réversible
 - Contient des bouteilles de 1 lt. et 1,5 lt. *
 - Crochet d'entraînement
 - R600a réfrigérant

* no TOP A+ 20 Lt.

** no TOP A+ 28 Lt. GLASS

	Mod. TOP A+ 28 Lt. GLASS	Mod. TOP A+ 20 Lt.	Mod. TOP A+ 28 Lt.	Mod. TOP A+ 30 Lt.	Mod. TOP A+ 40 Lt.
Colore	Nero (PVC)	Nero (PVC)	Nero (PVC)	Nero (PVC)	Nero (PVC)
Color	Black (PVC)	Black (PVC)	Black (PVC)	Black (PVC)	Black (PVC)
Coleur	Noir (PVC)	Noir (PVC)	Noir (PVC)	Noir (PVC)	Noir (PVC)
Tipo installazione	Incasso o libera	Incasso o libera	Incasso o libera	Incasso o libera	Incasso o libera
Installation type	Built-in or free	Built-in or free	Built-in or free	Built-in or free	Built-in or free
Installation	Encastrée	Encastrée ou libre	Encastrée ou libre	Encastrée ou libre	Encastrée ou libre
Classe energetica					
Energy class	ex A+	ex A+	ex A+	ex A+	ex A+
Classe énergétique	01-03-2021: class D	01-03-2021: class E	01-03-2021: class E	01-03-2021: class F	01-03-2021: class F
Volume refrigerato					
Refrigerated compartment	26 lt.	19 lt.	26 lt.	32 lt.	35 lt.
Volume					
Dimensioni esterne A x L x P					
External dimensions H x W x D	485 x 385 x 385 mm	440x360x390 mm	475x385x385 mm	475x385x455 mm	560x400x425 mm
Dimensions externe H x L x P					
Peso netto					
Net weight	13,1 Kg	9,0 Kg	10,1 Kg	10,9 Kg	12,8 Kg
Poids net					
Potenza assorbita					
Absorption System	63 W	63 W	63 W	63 W	63 W
Puissance absorbée					
Consumo giornaliero					
Daily consumption	0,285 kWh	0,284 kWh/24	0,285 kWh/24	0,266 kWh/24	0,269 kWh/24
Consommation journalière					
Consumo annuo					
Annual consumption	98 kWh	104 kWh	104 kWh	97 kWh	99kWh
Consommation annuelle					
n° ripiani interni regolabili					
n° adjustable transparent shelves	2	2	2	4	4
n° étagères internes réglables					



 HOTEL degli ARCIMBOLDI

VAMASAFE BASIC VAMASAFE LASERTOP



CE



DIGITAL DISPLAY
+ AUDIT

RoHS
2002/95/EC

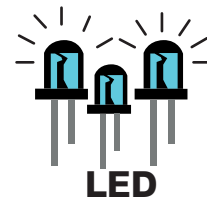

VAMASAFE LASERTOP

mod. 4339



dimensioni esterne AxLxP: 180x280x200 mm
dimensioni interne AxLxP: 150x270x180 mm
peso: 7 Kg

mod. 4346



dimensioni esterne AxLxP: 190x410x370 mm
dimensioni interne AxLxP: 160x395x340 mm
peso: 11 Kg

LAPTOP 15"

mod. 4353



dimensioni esterne AxLxP: 190x500x380 mm
dimensioni interne AxLxP: 160x490x360 mm
peso: 15 Kg

LAPTOP 17"

CARATTERISTICHE mod. 4339

Serratura elettronica	digitale motorizzata
Spessore della porta	5 mm - taglio laser
Spessore delle pareti	2 mm
Segnalazioni visive	su display
Display flat	LED a colori
Codice master	personalizzabile
Serratura emergenza	con chiave
Audit accessi	opzionale
Batterie	incluse
Fori di ancoraggio	base e schienale (2+2)
Tasselli per fissaggio	inclusi
Tappetino	interno incluso
Luce LED interna	inclusa
Colore	nero

mod. 4346

Serratura elettronica	digitale motorizzata
Spessore della porta	5 mm - taglio laser
Spessore delle pareti	2 mm
Segnalazioni visive	su display
Display flat	LED a colori
Codice master	personalizzabile
Serratura emergenza	con chiave
Audit accessi	opzionale
Batterie	incluse
Fori di ancoraggio	base e schienale (2+2)
Tasselli per fissaggio	inclusi
Tappetino	interno incluso
Luce LED interna	inclusa
Colore	nero

mod. 4353

Serratura elettronica	digitale motorizzata
Spessore della porta	5 mm - taglio laser
Spessore delle pareti	2 mm
Segnalazioni visive	su display
Display flat	LED a colori
Codice master	personalizzabile
Serratura emergenza	con chiave
Audit accessi	opzionale
Batterie	incluse
Fori di ancoraggio	base e schienale (2+2)
Tasselli per fissaggio	inclusi
Tappetino	interno incluso
Luce LED interna	inclusa
Colore	nero

VAMASAFE BASIC

mod. 3745

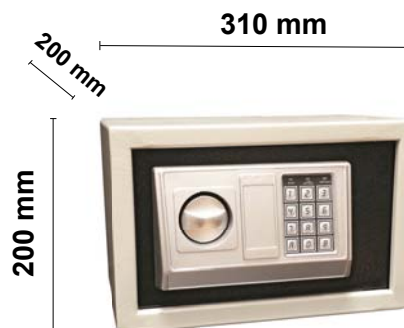

dimensioni esterne AxLxP: 200x310x200 mm

dimensioni interne AxLxP: 190x295x190 mm

peso: 7,5 Kg

mod. 3752

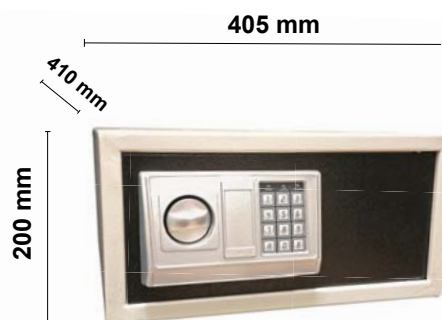

dimensioni esterne AxLxP: 200x405x410 mm

dimensioni interne AxLxP: 190x400x385 mm

peso: 14,5 Kg

LAPTOP 15"

CARATTERISTICHE

	mod. 3745	mod. 3752
Serratura elettronica	digitale meccanica	digitale meccanica
Spessore della porta	3 mm	3 mm
Spessore delle pareti	2 mm	2 mm
Segnalazioni sonore	SI	SI
Display	NO	NO
Codice master	personalizzabile	personalizzabile
Serratura emergenza	con chiave	con chiave
Audit accessi	NO	NO
Batterie	escluse	escluse
Fori di ancoraggio	base e schienale (2+2)	base e schienale (2+2)
Tasselli per fissaggio	inclusi	inclusi
Tappetino	interno incluso	interno incluso
Luce LED interna	esclusa	esclusa
Colore	grigio + nero	grigio + nero



VAMASAFE LASERTOP

FEATURES / CARACTÉRISTIQUES

Digital motorized electronic lock
Serrure électronique numérique motorisée
Thickness of door 5 mm
Épaisseur de la porte de 5 mm
Thickness of walls 2 mm
Épaisseur des murs de 2 mm
Visual signalling on high contrast LED's display
Signalisation visuels et sonores par des moyens de LED-et buzzer
Audit trail to know the last 100 events from display optional
Visualisation dernière 100 events option
Changeable master code and emergency key override for the Hotel Management
Code maître modifiable et clé de dérivation d'urgence pour la gestion Hôtel
Emergency lock and key for manager use
Verrouillage d'urgence clé pour mécanique utilisation par Hotelier
Batteries included
Piles fournies
Fixing holes on back and base (2+2)
Les trous de fixation sur le dos et la base (2+2)
Expansion bolts included
Chevilles pour fixation inclus
Cover carpet provided, interior LED lighting
Tapis et éclairage intérieur LED
Powder coated finish, black
Revêtement en poudre finition en noir



VAMASAFE BASIC

FEATURES / CARACTÉRISTIQUES

Digital electronic lock
Serrure électronique numérique
Thickness of door 3 mm
Épaisseur de la porte de 3 mm
Thickness of walls 2 mm
Épaisseur des murs de 2 mm
Digital electronic lock with permanent memory
Numérique serrure électronique avec une mémoire permanente
Visual and acoustic signalling by means of leds and buzzer
Signalisation visuels et sonores par des moyens de LED-et buzzer
Changeable master code and emergency key override for the Hotel Management
Code maître modifiable et clé de dérivation d'urgence pour la gestion Hôtel
Emergency mechanical key
Verrouillage d'urgence et la clé pour une utilisation par Hotelier
Batteries not included
Piles non incluses
Fixing holes on back and base (2+2)
Les trous de fixation sur le dos et la base (2+2)
Expansion bolts included
Chevilles pour fixation inclus
Cover carpet provided
Tapis intérieur
Powder coated finish, grey + black colour
Revêtement en poudre finition en gris + noir

PLEASURE



CARATTERISTICHE TECNICHE

TECHNICAL FEATURES / CARACTÉRISTIQUES TECHNIQUES

Tensione	
Supply Voltage	220 V-240 V
Tension d'alimentation	
Grado di protezione elettrica	
Electrical Protection Level	CLASS I
Isolation électrique	
Frequenza	
Frequency	50-60 Hz
Fréquence	
Potenza	
Power	1500 W
Puissance	
Garanzia	2 anni
Warranty	2 years
Garantie	2 ans
Lunghezza cavo alimentazione 90 cm, con spina shuko	
90 cm power supply cable, with shuko plug	
Longueur du cable 90 cm, avec fiche shuko	

🇮🇹 BOLLITORE ELETTRICO PLEASURE

Bollitore d'acqua elettrico in acciaio inox per hotel. Capacità max. 1,2 litri. Spegnimento automatico al raggiungimento della temperatura di ebollizione. Indicatore funzionamento luminoso.

🇬🇧 ELECTRIC KETTLE PLEASURE

Kettle in stainless steel for hotels. Capacity max. 1.2 liters. Auto power-off at boiling temperature. Operation indicator.

🇫🇷 BOUILLLOIRE ELECTRIQUE PLEASURE

Bouilloire en acier inoxydable pour les hôtels. Capacité max. 1,2 litres. Mise hors tension automatique à la réalisation des la température d'ébullition. Voyant de fonctionnement lumineux.



- Gamma completa elegante di alta qualità
 - Ottone cromato
 - Facile montaggio e manutenzione
 - Viteria Inox fornita
- A range of high quality and modern design accessories
 - Made of chrome plated brass
 - Easy to install and maintenance
 - Stainless steel screws (included)
- Gamme de conception moderne de haute qualité
 - Matériau en laiton chromé
 - Facile à installer et à entretenir
 - Vis en acier inoxydable (incluses)



- Porta biancheria
 Bath towels shelf
 Etendoir

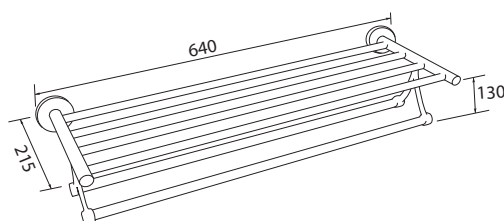



CARATTERISTICHE TECNICHE
TECHNICAL FEATURES / CARACTÉRISTIQUES TECHNIQUES

Cod.	Lunghezza Lenght Longueur	Larghezza Width Largeur	Altezza Height Hauteur
4018	640	215	130

Peso/Weight/Poids: 1,16 Kg

LINEA HOTEL - HOTEL LINE - LIGNE HOTEL



-  Porta asciugamani doppio
-  Towel holder double bar
-  Porte-serviettes double

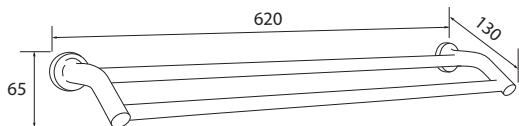



CARATTERISTICHE TECNICHE
TECHNICAL FEATURES / CARACTÉRISTIQUES TECHNIQUES

Cod.	Lunghezza Lenght Longueur	Larghezza Width Largeur	Altezza Height Hauteur
4025	620	130	65

Peso/Weight/Poids: 0,58 Kg



-  Porta asciugamani singolo 620 mm
-  Towel holder single bar 620 mm
-  Porte-serviettes 620 mm

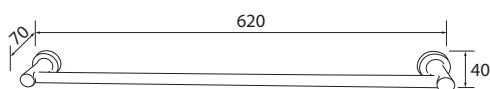



CARATTERISTICHE TECNICHE
TECHNICAL FEATURES / CARACTÉRISTIQUES TECHNIQUES

Cod.	Lunghezza Lenght Longueur	Larghezza Width Largeur	Altezza Height Hauteur
4032	620	70	40

Peso/Weight/Poids: 0,22 Kg



-  Porta asciugamani singolo 450 mm
-  Towel holder single bar 450 mm
-  Porte-serviettes 450 mm

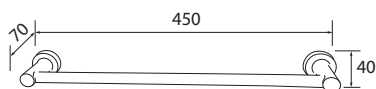



CARATTERISTICHE TECNICHE
TECHNICAL FEATURES / CARACTÉRISTIQUES TECHNIQUES

Cod.	Lunghezza Lenght Longueur	Larghezza Width Largeur	Altezza Height Hauteur
4049	450	70	40

Peso/Weight/Poids: 0,20 Kg



-  Porta asciugamani singolo 320 mm
-  Towel holder single bar 320 mm
-  Porte-serviettes 320 mm

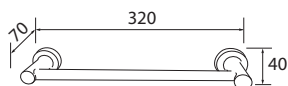



CARATTERISTICHE TECNICHE
TECHNICAL FEATURES / CARACTÉRISTIQUES TECHNIQUES

Cod.	Lunghezza Lenght Longueur	Larghezza Width Largeur	Altezza Height Hauteur
4056	320	70	40

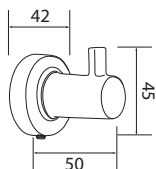
Peso/Weight/Poids: 0,28 Kg







-  Appendiabito 1 gancio
-  1 heads bath robe hanger
-  Portemanteau 1 crochet

CARATTERISTICHE TECNICHE TECHNICAL FEATURES / CARACTÉRISTIQUES TECHNIQUES

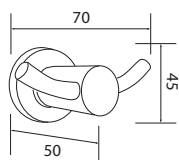
Cod.	Lunghezza Lenght Longueur	Larghezza Width Largeur	Altezza Height Hauteur
4063	42	50	45

Peso/Weight/Poids: 0,06 Kg







-  Appendiabito 2 ganci
-  2 heads bath robe hanger
-  Portemanteau 2 crochets

CARATTERISTICHE TECNICHE TECHNICAL FEATURES / CARACTÉRISTIQUES TECHNIQUES

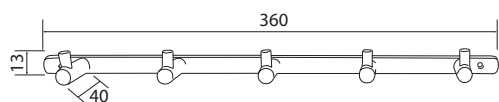
Cod.	Lunghezza Lenght Longueur	Larghezza Width Largeur	Altezza Height Hauteur
4070	70	50	45

Peso/Weight/Poids: 0,12 Kg







-  Appendiabito 5 ganci
-  5 heads bath robe hanger
-  Portemanteau 5 crochets

CARATTERISTICHE TECNICHE TECHNICAL FEATURES / CARACTÉRISTIQUES TECHNIQUES

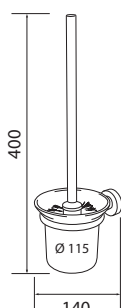
Cod.	Lunghezza Lenght Longueur	Larghezza Width Largeur	Altezza Height Hauteur
4087	360	40	13

Peso/Weight/Poids: 0,34 Kg



-  Portascopino in vetro
-  Glass toilet brush holder
-  Porte-balais wc en verre

CARATTERISTICHE TECNICHE TECHNICAL FEATURES / CARACTÉRISTIQUES TECHNIQUES

Cod.	Lunghezza Lenght Longueur	Larghezza Width Largeur	Altezza Height Hauteur
4094	Ø 115	140	400

Peso/Weight/Poids: 0,46 Kg

LINEA HOTEL - HOTEL LINE - LIGNE HOTEL

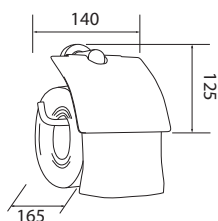

- Porta rotolo
- Toilet paper holder
- Porte-rouleau

CARATTERISTICHE TECNICHE
TECHNICAL FEATURES / CARACTÉRISTIQUES TECHNIQUES

Cod.	Lunghezza Lenght Longueur	Larghezza Width Largeur	Altezza Height Hauteur
4100	140	165	125

Peso/Weight/Poids: 0,22 Kg

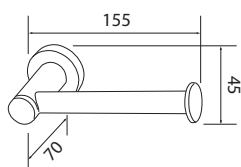

- Porta rotolo di riserva
- Spare toilet roll holder
- Porte-rouleau de rechange

CARATTERISTICHE TECNICHE
TECHNICAL FEATURES / CARACTÉRISTIQUES TECHNIQUES

Cod.	Lunghezza Lenght Longueur	Larghezza Width Largeur	Altezza Height Hauteur
4117	155	70	45

Peso/Weight/Poids: 0,14 Kg

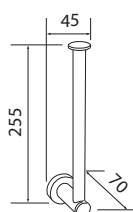

- Porta rotolo di riserva doppio
- Spare toilet roll holder double
- Porte-rouleau de rechange double

CARATTERISTICHE TECNICHE
TECHNICAL FEATURES / CARACTÉRISTIQUES TECHNIQUES

Cod.	Lunghezza Lenght Longueur	Larghezza Width Largeur	Altezza Height Hauteur
4124	45	70	255

Peso/Weight/Poids: 0,16 Kg

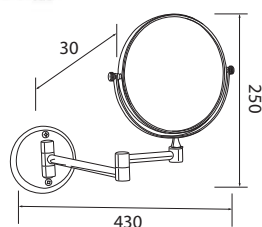





- Specchio con lente Ø 200 mm, ingrandimento 3x
- Mirror with lens Ø 200 mm, 3x magnifying factor
- Miroir avec lens Ø 200 mm, grossissement 3x

CARATTERISTICHE TECNICHE
TECHNICAL FEATURES / CARACTÉRISTIQUES TECHNIQUES

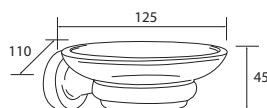
Cod.	Lunghezza Lenght Longueur	Larghezza Width Largeur	Altezza Height Hauteur
4131	430	30	250

Peso/Weight/Poids: 0,68 Kg







-  Porta sapone con piatto in vetro
-  Soap dish
-  Porte-savon avec plat en verre

CARATTERISTICHE TECNICHE
TECHNICAL FEATURES / CARACTÉRISTIQUES TECHNIQUES

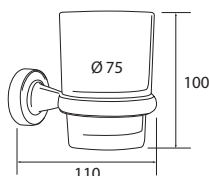
Cod.	Lunghezza Lenght Longueur	Larghezza Width Largeur	Altezza Height Hauteur
4148	110	125	45

Peso/Weight/Poids: 0,35 Kg







-  Porta bicchiere
-  Toilet glass holder
-  Porte-verre

CARATTERISTICHE TECNICHE
TECHNICAL FEATURES / CARACTÉRISTIQUES TECHNIQUES

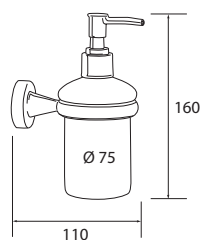
Cod.	Lunghezza Lenght Longueur	Larghezza Width Largeur	Altezza Height Hauteur
4155	Ø 75	110	100

Peso/Weight/Poids: 0,28 Kg







-  Porta sapone liquido
-  Liquid soap holder
-  Porte-savon liquide

CARATTERISTICHE TECNICHE
TECHNICAL FEATURES / CARACTÉRISTIQUES TECHNIQUES

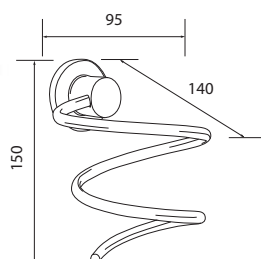
Cod.	Lunghezza Lenght Longueur	Larghezza Width Largeur	Altezza Height Hauteur
4162	Ø 75	110	160

Peso/Weight/Poids: 0,30 Kg



-  Supporto phon universale a muro
-  Hair dryer universal holder
-  Support mural sèche cheveux universel



CARATTERISTICHE TECNICHE
TECHNICAL FEATURES / CARACTÉRISTIQUES TECHNIQUES

Cod.	Lunghezza Lenght Longueur	Larghezza Width Largeur	Altezza Height Hauteur
4179	95	140	150

Peso/Weight/Poids: 0,22 Kg

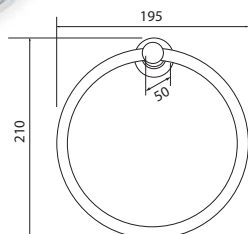
LINEA HOTEL - HOTEL LINE - LIGNE HOTEL







-  Porta asciugamani ad anello
-  Towel ring
-  Anneau porte-serviette

CARATTERISTICHE TECNICHE
TECHNICAL FEATURES / CARACTÉRISTIQUES TECHNIQUES

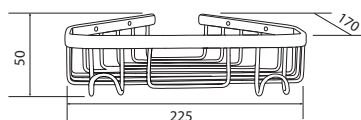
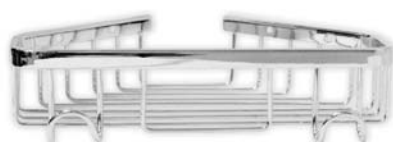
Cod.	Lunghezza Lenght Longueur	Larghezza Width Largeur	Altezza Height Hauteur
4186	195	50	210

Peso/Weight/Poids: 0,12 Kg







-  Portaoggetti doccia angolare
-  Corner shower caddy
-  Porte-objets douche angulaire

CARATTERISTICHE TECNICHE
TECHNICAL FEATURES / CARACTÉRISTIQUES TECHNIQUES

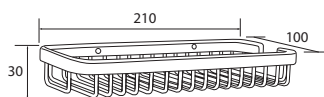
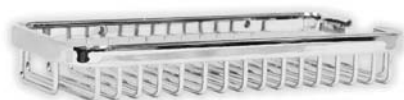
Cod.	Lunghezza Lenght Longueur	Larghezza Width Largeur	Altezza Height Hauteur
4193	225	170	50

Peso/Weight/Poids: 0,48 Kg



-  Portaoggetti doccia
-  Shower caddy
-  Porte-objets douche

CARATTERISTICHE TECNICHE
TECHNICAL FEATURES / CARACTÉRISTIQUES TECHNIQUES

Cod.	Lunghezza Lenght Longueur	Larghezza Width Largeur	Altezza Height Hauteur
4209	210	100	30

Peso/Weight/Poids: 0,40 Kg

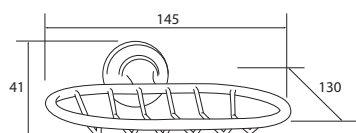

-  Porta sapone
-  Soap dish
-  Porte-savon

CARATTERISTICHE TECNICHE
TECHNICAL FEATURES / CARACTÉRISTIQUES TECHNIQUES

Cod.	Lunghezza Lenght Longueur	Larghezza Width Largeur	Altezza Height Hauteur
4216	145	130	41

Peso/Weight/Poids: 0,14 Kg



COMUNITÀ



Communities - Collectivité



PRO PHON - FIT PHON 1000W

ASCIUGACAPELLI - HAIR DRYERS - SÈCHE-CHEVEUX

FIT PHON 1000W

-  **Pulsante a rilascio**
Cavo spiralato 0,5 mt. + cavo lineare 1,5 mt
con spina bipolare Italia
Risparmio energetico, max. 1000 W
-  **Push / release button**
Cable length 0,5 mt. (coiled) + 1,5 mt.
(linear), with plug
Energy saving, max. 1000 W
-  **Bouton-poussoir**
Cable 0,5 mt. (spirale) + 1,5 mt. (linéaire),
avec prise bipolaire
Épargné énergétique, max. 1000 W



CARATTERISTICHE TECNICHE / TECHNICAL FEATURES / CARACTÉRISTIQUES TECHNIQUES

Funzionamento	Pulsante a rilascio	Potenza	max. 1000 W	Peso	
Functioning	Push / release button	Power	max. 1000 W	Weight	0,900 Kg
Activation	Bouton-poussoir	Puissance	max. 1000 W	Poids net	
Grado di protezione elettrica		Frequenza		Materiale	ABS bianco / nero
Electrical Protection Level	CLASS II	Frequency	50-60 Hz	Materials	ABS white / black
Isolation électrique		Fréquence		Matériel	ABS blanc / noir
Tensione		Volume aria		Dimensioni A x L x P	
Supply Voltage	220 V-240 V	Air Flow	max. 30,0 L/s	Dimensions H x W x D	287 x 275 x 95 (mm)
Tension d'alimentation		Débit d'air		Dimensions H x L x P	



PRO PHON 1800W

-  **Pulsante on / off**
Cavo spiralato 0,5 mt. + cavo lineare 1,00 mt
con spina bipolare Italia
Potenza max. 1800 W
-  **On / off button**
Cable length 0,5 mt. (coiled) + 1,00 mt. (linear),
with plug
Max. power 1800 W
-  **Bouton on / off**
Cable 0,5 mt. (spirale) + 1,00 mt. (linéaire),
avec prise bipolaire
Puissance max. 1800 W



CARATTERISTICHE TECNICHE / TECHNICAL FEATURES / CARACTÉRISTIQUES TECHNIQUES

Funzionamento	Tasto ON/OFF	Potenza	max. 1800 W	Peso	
Functioning	ON/OFF switch	Power	max. 1800 W	Weight	0,500 Kg
Activation	Bouton ON/OFF	Puissance	max. 1800 W	Poids net	
Grado di protezione elettrica		Frequenza		Materiale	
Electrical Protection Level	CLASS II	Frequency	50-60 Hz	Materials	ABS
Isolation électrique		Fréquence		Matériel	
Tensione		Volume aria		Dimensioni A x L x P	
Supply Voltage	220 V-240 V	Air Flow	max. 30,0 L/s	Dimensions H x W x D	205 x 225 x 91 (mm)
Tension d'alimentation		Débit d'air		Dimensions H x L x P	

-  **SUPPORTO PHON UNIVERSALE (OPZIONALE)**
Base murale in ABS nero, con blocca cavo all'interno del supporto, ideale per uso comunitario.
-  **BLACK ABS WALL BASE (OPTION)** Cable Locking inside, recommended for heavy traffic.
-  **SUPPORT MURAL EN ABS (OPTIONNEL)**
Support mural en ABS noir, avec fixation antivol du câble, pour usage intensif.



Stream Dry Hair

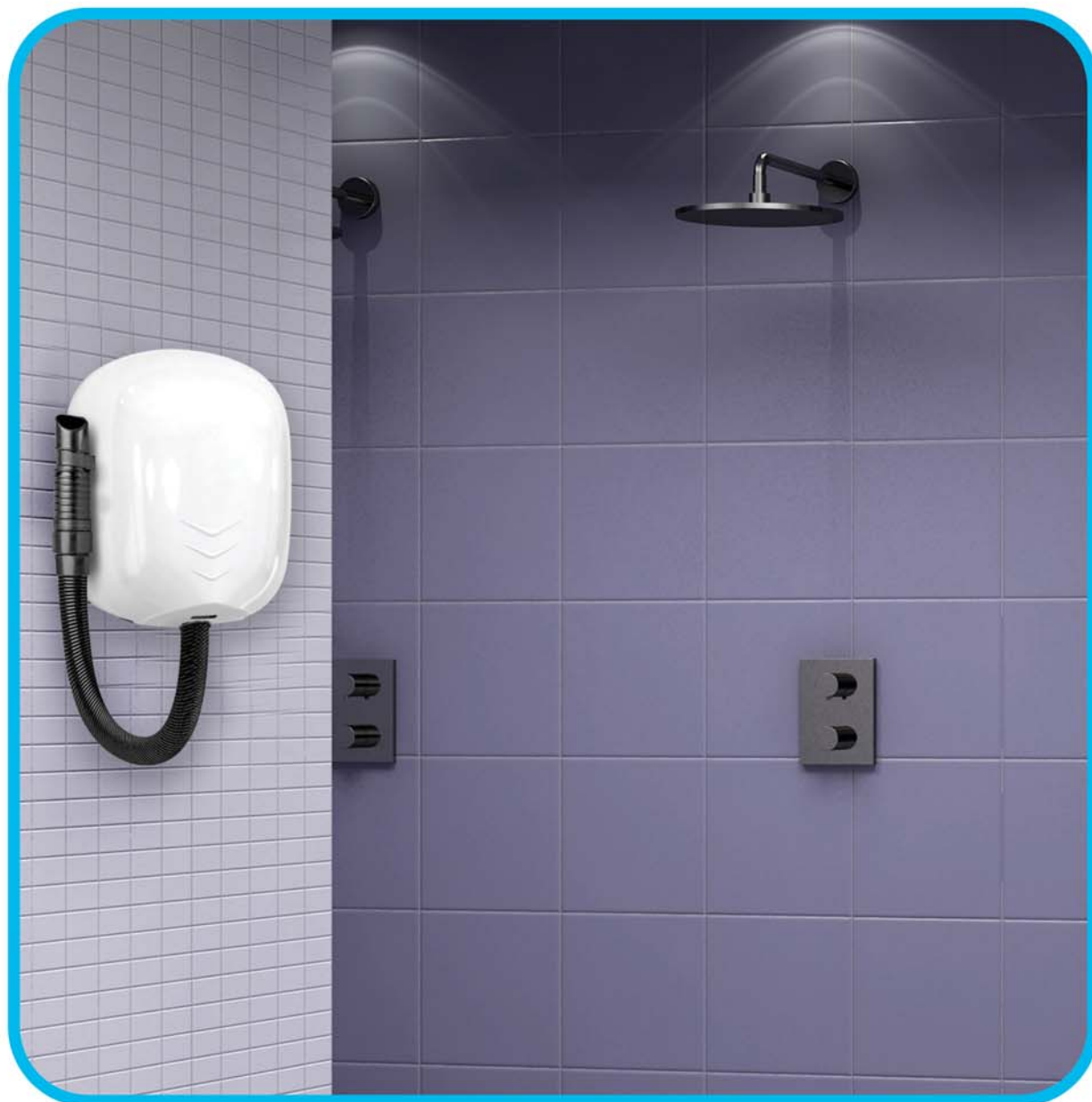

VELOCITÀ ASCIUGATURA
DRYING TIME / TEMPS DE SÉCHAGE



RISPARMIO ENERGETICO
ENERGY SAVING / ÉPARGNE ENERGETIQUE



SILENZIOSITÀ
NOISELESS / SILENCIEUX



DESIGN



ANTIVANDALISMO
ANTIVANDALISM / ANTIVANDALISME



STREAM DRY HAIR

ASCIUGACAPELLI - HAIR DRYERS - SÈCHE-CHEVEUX

Stream
Dry Hair



1100 W



MADE IN ITALY

-  - **Asciugacapelli ECO-JET in acciaio antivandalo**, con tubo estensibile antistrappo.

 - Grande risparmio energetico, assorbimento pari a soli 1100 W
 - Ampia gamma di modelli e finiture: versioni a smalto di colore bianco o nero-goffrato e in acciaio INOX AISI 304 lucido e satinato
 - Massima sicurezza: doppio termostato sia sulla resistenza che sul motore.

-  - **ECO-JET hair dryer, vandal-proof steel cover**, with hose

 - 300 km/h air speed
 - Energy saving: max. power 1100 W
 - Wide range of models and finishings: white and black embossed painted, AISI 304 stainless steel satin and bright
 - Maximum safety: double thermostat on resistance / engine

-  - **Sèche-cheveux ECO-JET en acier anti-vandalisme**, avec tube extensible anti-déchirure.

 - Vitesse de l'air de 300 Km/h
 - Grande économie d'énergie, absorption de seulement 1100 W.
 - Large gamme de modèles et de finitions: version en émail blanc ou gaufré noire et en acier inoxydable AISI 304 poli et satiné.
 - Sécurité maximale: double thermostat sur la résistance et le moteur.



Cod.

STREAM DRY HAIR ABS	Polipropilene bianco / Polypropylene white / Polypropylène blanc
STREAM DRY HAIR BF	Acciaio verniciato bianco / Stainless steel white / Acier blanc
STREAM DRY HAIR LF	Acciaio inox AISI 304 lucido / Bright AISI 304 stainless steel / Acier inox Aisi 304 brillant
STREAM DRY HAIR SF	Acciaio inox AISI 304 satinato / Satin AISI 304 stainless steel / Acier AISI 304 satin
STREAM DRY HAIR NF	Acciaio con verniciatura goffrata nera / Black metallic paint, embossed finish / Acier avec peinture métallisée noire, finition en relief



Polipropilene bianco



INOX bianco (BF)



INOX satinato (SF)



INOX cromato (LF)



- Funzionamento a pulsante, temporizzazione pari a 40 sec.
- Push-button operating, drying time 40 sec.
- Fonctionnement par bouton-poussoir, chronométré à 40 sec.



- Gancio in acciaio per appendere il tubo flessibile
- Stainless steel hook for hanging the flexible hose
- Crochet en acier inoxydable pour suspendre le tuyau flexible

CARATTERISTICHE TECNICHE / TECHNICAL FEATURES / CARACTÉRISTIQUES TECHNIQUES

Giri al minuto	
Tr min	26.000 rpm
Revolutions per minute	
Grado di protezione elettrica	
Electrical Protection Level	CLASS II - IP 23
Isolation électrique	
Tensione	
Supply Voltage	220 V-240 V
Tension d'alimentation	
Potenza totale	
Total power	1100 W
Puissance total	
Potenza resistenza	
Absorption Heating Element	550 W
Puissance chauffage	
Potenza motore	
Absorption Motor	550 W
Puissance moteur	
Dimensioni A x L x P	285 x 221 x 157 mm (tubo escluso)
Dimensions H x W x D	285 x 221 x 157 mm (without hose)
Dimensions H x L x P	285 x 221 x 157 mm (sans tube)
Frequenza	
Frequency	50-60 Hz
Fréquence	
Velocità aria	
Air Speed	300 Km/h
Vitesse d'air	
Volume aria	
Air Flow	187 mc/h
Débit d'air	

Peso	
Weight	3,00 Kg polipropilene - 3,50 Kg acciaio
Poids net	
Materiale	Polipropilene - Acciaio INOX
Materials	Polypropylene - Steel
Matériel	Polypropylène - Acier
Marchi di qualità	
Quality marks - certifications	CE
Certification	
Rumorosità (2 mt)	
Noise Level (2 mt)	75 dB
Niveau sonore (2 mt)	
Garanzia	2 anni*
Warranty	2 years*
Garantie	2 ans*

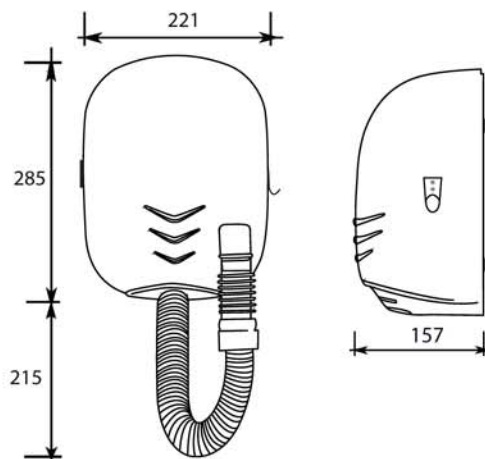

* Per le limitazioni di garanzia si vedano le condizioni generali di servizio

* Limited warranty. Please have a look to the General Warranty Conditions for details and consumables

* Limitations de garantie: en revoir Conditions de Garantie Generale

ARIEL HAIR - ARIEL HAIR CON TUBO

ASCIUGACAPELLI / HAIR DRYERS / SÈCHE-CHEVEUX





ARIEL HAIR /BP
(2400 W - 1700 W)



ARIEL HAIR CON TUBO / BP (1200 W)
ARIEL HAIR WITH HOSE / BP (1200 W)
ARIEL HAIR AVEC TUBE / BP (1200 W)

- 

Asciugacapelli in acciaio antivandalo, funzionante a pulsante, potenza 2400 W o 1700 W. Disponibile anche nella versione con tubo estensibile antistrappo (ARIEL HAIR CON TUBO), potenza 1200 W.
Ampia gamma di modelli e finiture: versione a smalto di colore bianco, in acciaio INOX AISI 304 lucido e satinato.
Timer regolabile tra 30 sec. - 3 min.
Massima sicurezza: doppio termostato sia sulla resistenza che sul motore.
- 

Hair dryer in vandal-proof steel, push- button operating, power 2400 W or 1700 W. Also available with hose (ARIEL HAIR WITH HOSE), power 1200 W.
Wide range of models and finishings: white version or AISI 304 stainless steel satin and bright.
Timer adjustable from 30 sec - 2 min. 30 sec.
Maximum safety: double thermostat on resistance / engine.
- 

Sèche-cheveux en acier anti-vandalisme, avec bouton poussoir, puissance 2400 W ou 1700 W.
Disponible avec tube extensibles (ARIEL HAIR AVEC HOSE), puissance 1200 W.
Large gamme de modèles et de finitions: version de couleur blanc, en acier inox AISI 304 satiné au brillant.
Minuterie réglable de 30 sec - 2 min. 30 sec.
Sécurité maximale: double thermostat sur la résistance et sur le moteur.









MODELLI & CODICI - PRODUCT CODES - CODES DE PRODUIT

	CODICI / CODES	COLORE COLOR COULEUR	POTENZA POWER PUISSANCE	FUNZIONAMENTO OPERATION FONCTIONNEMENT	TIMER
	ARIEL HAIR /BP	Bianco white / blanc	2400 W / 1700 W	Pulsante Push button Poussoir	30 sec. - 3 min.
	ARIEL HAIR /SP	Satinato Brushed / Satin	2400 W / 1700 W		
	ARIEL HAIR /LP	Lucido Bright / Brillant	2400 W / 1700 W		
	ARIEL HAIR CON TUBO (with hose / avec tube) /BP	Bianco white / blanc	1200 W		
	ARIEL HAIR CON TUBO (with hose / avec tube) /SP	Satinato Brushed / Satin	1200 W		
	ARIEL HAIR CON TUBO (with hose / avec tube) /LP	Lucido Bright / Brillant	1200 W		

ARIEL HAIR - ARIEL HAIR CON TUBO

ASCIUGACAPELLI / HAIR DRYERS / SÈCHE-CHEVEUX



-  Saliscendi per ARIEL HAIR in acciaio INOX AISI 304 lucido.
Dimensioni (A x L x P) 1000 X 300 X 150 mm; peso kg 23,50.
-  Height adjuster for ARIEL HAIR. AISI 304 bright stainless steel
Dimensions (H x W x D) 1000 X 300 X 150 mm; weight kg 23,50.
-  Systeme de réglage en hauteur des appareils ARIEL HAIR, en acier inox AISI 304 brillant
Dimensions (H x L x P) 1000 X 300 X 150 mm; poids net kg 23,50.
-  ABBINALO ALLA GETTONIERA GET/1 oppure GET/REG
-  Match it with GET/1 or GET/REG
-  Utilisation avec monnayeur GET/1 ou GET/REG



CARATTERISTICHE TECNICHE / TECHNICAL FEATURES / CARACTÉRISTIQUES TECHNIQUES

Giri al minuto	
Tr min	5500 rpm
Revolutions per minute	
Grado di protezione elettrica	
Electrical Protection Level	CLASS I - IP20
Isolation électrique	
Tensione	
Supply Voltage	220 V-240 V
Tension d'alimentation	
Potenza totale	2400 - 1700W (ARIEL HAIR)
Total power	1200W (ARIEL HAIR con tubo/with hose/avec tube)
Puissance total	
Potenza resistenza	2200 - 1500W (ARIEL HAIR)
Absorption Heating Element	1000W (ARIEL HAIR con tubo/with hose/avec tube)
Puissance chauffage	
Potenza motore	
Absorption Motor	200W
Puissance moteur	
Dimensioni A x L x P	
Dimensions H x W x D	243 x 278 x 213 (mm)
Dimensions H x L x P	
Frequenza	
Frequency	50-60 Hz
Fréquence	
Velocità aria	
Air Speed	101 Km/h , 30 m/s
Vitesse d'air	
Volume aria	
Air Flow	90 L/s , 330 cbm/h
Débit d'air	

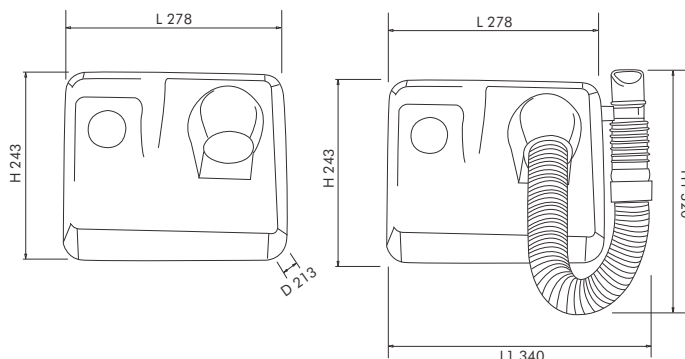
Peso	
Weight	4,8 Kg - 5,5 Kg con tubo
Poids net	
Materiale	Acciaio
Materials	Steel
Matériel	Acier
Marchi di qualità	
Quality marks - certifications	CE
Certification	
Rumorosità (2 mt)	
Noise Level (2 mt)	70 dB
Niveau sonore (2 mt)	
Garanzia	2 anni*
Warranty	2 years*
Garantie	2 ans*



Dimensioni tubo interno ø 38 mm
Dimensioni tubo esterno ø 46 mm
Dimensioni tubo estensibile 1.2 mt

-  * Per le limitazioni di garanzia si vedano le condizioni generali di servizio
-  * Limited warranty. Please have a look to the General Warranty Conditions for details and consumables
-  * Limitations de garantie: en voir Conditions de Garantie Generale

UNIK HAIR - ACEA

ASCIUGACAPELLI / HAIR DRYERS / SÈCHE-CHEVEUX



UNIK HAIR



ACEA

ASCIUGACAPELLI PROFESSIONALI IN ABS

- Ottimo rapporto tra performance / consumi / budget di spesa
- Massima silenziosità: inferiore a 60 db
- Motore a induzione
- Grande varietà di gamma: versioni a 1200 W e 1600 W (solo ACEA SUPER), con funzionamento a pulsante o a mezzo di dispositivo per la gestione dei servizi a pagamento (gettoniera)
- Temporizzazione fissa 3 min. (ACEA), regolabile tra 30 sec. - 3 min (UNIK HAIR)
- Termostato di sicurezza

PROFESSIONAL ABS HAIR DRYERS

- The best balance between performance / electricity consumption / budget
- Noiseless: less than 60 db
- Brushless motors
- Wide range: 1200 W version or 1600 W (ACEA SUPER ONLY). Push button or coin unit operating
- Timer 3 min., (ACEA); adjustable timer 30 sec. - 3 min. (UNIK HAIR)
- Overheating protection.

SÈCHE-CHEVEUX PROFESSIONNEL

- Excellentes relations entre la performance / consommations / budget des dépenses.
- Niveau sonore: moins de 60 db.
- Moteur à induction.
- Grande variété des versions: 1200 W et 1600 W (ACEA SUPER), avec bouton poussoir ou capteur ou system de paiement.
- Minuterie 3 min (ACEA), réglable de 30 sec. - 3 min (UNIK HAIR).
- Thermostat de sécurité.



 * Per le limitazioni di garanzia si vedano le condizioni generali di servizio



 * Limited warranty. Please have a look to the General Warranty Conditions for details and consumables

 * Limitations de garantie: en revoir Conditions de Garantie Generale



UNIK HAIR - ACEA



ASCIUGACAPELLI/ HAIR DRYERS / SÈCHE-CHEVEUX



-  Saliscendi per ACEA in acciaio INOX AISI 304 lucido.
Dimensioni (A x L x P) 1040 X 340 X 120 mm; peso 6 kg
-  Height adjuster for ACEA. AISI 304 bright stainless steel
Dimensions (H x W x D) 1040 X 340 X 120 mm; weight 6 kg
-  Systeme de réglage en hauteur des appareils ACEA en acier inox AISI 304 brillant
Dimensions (H x L x P) 1040 X 340 X 120 mm; poids net 6 kg



-  ABBINALO ALLA GETTONIERA GET/1 – GET/REG
-  Match it with GET/1 – GET/REG
-  Utilisation avec monnayeur GET/1 – GET/REG

	CODICI / CODES	COLORE COLOR COULEUR	POTENZA POWER PUISSANCE	FUNZIONAMENTO OPERATION FONCTIONNEMENT	TIMER
	UNIK HAIR /BP	Bianco white blanc	1200 W	Pulsante/Push button/Poussoir	30 sec. - 3 min.
	UNIK/HAIR/GET			Gettoniera/Coin Unit Système de monnayeur GET/1	30 sec. - 3 min.
	UNIK/HAIR/ SPECIAL			Gettoniera/ Coin Unit Système de monnayeur GET/REG	30 sec. - 6 min.
	ACEA/87	Bianco white blanc	1200 W	Pulsante/Push button/Poussoir	3 min.
	ACEA/SUPER/87		1600 W	Pulsante/Push button/Poussoir	3 min.
	ACEA/E/SUPER/87			Automatico/Sensor/Capteur	//
	ACEA/GET		1200 W 1600 W	Gettoniera/ Coin Unit Système de monnayeur GET/1	3 min.
	ACEA/SPECIAL			Gettoniera/ Coin Unit Système de monnayeur GET/REG	30 sec. - 6 min.

CARATTERISTICHE TECNICHE

TECHNICAL FEATURES / CARACTÉRISTIQUES TECHNIQUES

Tensione	
Supply Voltage	220 V-240 V
Tension d'alimentation	
Frequenza	
Frequency	50-60 Hz
Fréquence	
Volume aria	
Air Flow	45 L/s , 160 cbm/h
Débit d'air	
Peso	
Weight	3 kg
Poids net	
Materiale	
Materials	ABS
Matériel	
Marchi di qualità	
Quality marks - certifications	CE
Certification	
Rumorosità (2 mt)	
Noise Level (2 mt)	60 db
Niveau sonore (2 mt)	

UNIK HAIR

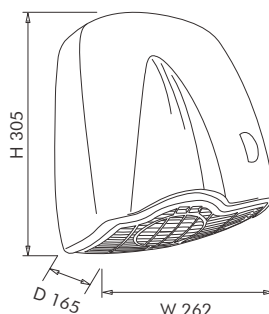

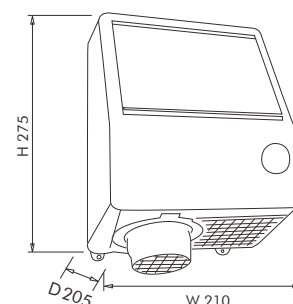

ACEA



TURBO3

ASCIUGACAPELLI / HAIR DRYERS / SÈCHE-CHEVEUX

-  - Asciugacapelli in ABS con tubo flessibile
- Potenza 700 W
- Attivazione automatica quando si sgancia il tubo (standard)
Abbinabile a dispositivo per la gestione dei servizi a pagamento (gettoniera)
- Autospegnimento dopo 5 min. in caso di mancato riaggancio del tubo
- Termostato di sicurezza

-  - Wall mounted ABS hair dryer with flexible hose
- Potenza 700 W
- Auto turn-on when hose is released (standard version)
Available coin unit operating model
- Auto turn off after 5 min
- Overheating protection

-  - Sèche-cheveux mural en ABS avec tube extensible
- Puissance 700 W
- Automatique (standard) / Avec Systeme de temporisateur
- Arrêt automatique (auto-timer): au bout de 5 minutes en cas de non repositionnement du tube
- Thermostat de sécurité



 * Per le limitazioni di garanzia si vedano le condizioni generali di servizio

 * Limited warranty. Please have a look to the General Warranty Conditions for details and consumables

 * Limitations de garantie: en revoir Conditions de Garantie Generale



 ABBINALO ALLA GETTONIERA GET/REG

 Match it with GET/REG

 Utilisation avec monnaie GET/REG



CARATTERISTICHE TECNICHE / TECHNICAL FEATURES / CARACTÉRISTIQUES TECHNIQUES

Funzionamento	Allo sganciamento del tubo
Functioning	Auto turn-on when hose is released
Activation	Automatique a la poignée
Grado di protezione elettrica	
Electrical Protection Level	CLASS II
Isolation électrique	
Tensione	
Supply Voltage	220 V-240 V
Tension d'alimentation	
Potenza	
Power	700 W
Puissance	
Frequenza	
Frequency	50-60 Hz
Fréquence	
Volume aria	
Air Flow	45 L/s , 160 cbm/h
Débit d'air	
Peso	
Weight	2,7 kg
Poids net	

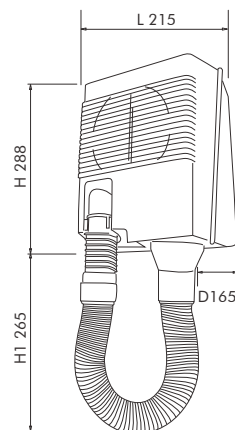
Materiale	
Materials	ABS
Matériel	



Dimensioni tubo interno \varnothing 38 mm
Dimensioni tubo esterno \varnothing 46 mm
Dimensioni tubo estensibile 1 mt

	CODICI / CODES	COLORE COLOR COULEUR	POTENZA POWER PUISSANCE	FUNZIONAMENTO OPERATION FONCTIONNEMENT	TIMER
	TURBO/3	Bianco white / blanc	700 W	Alla estrazione del tubo When hose is pull out Engageant la poignée	5 min.
	TURBO/SPECIAL			Gettoniera / Coin Unit Systeme de monnaie GET REG	30 sec. - 6 min.

- 

Gamma completa di dispositivi per la fornitura di servizi a pagamento.
 Enorme varietà di applicazioni, dalla temporizzazione di numerose tipologie di apparecchi (asciugacapelli, docce, lavatrici e asciugatrici, idromassaggi, illuminazione campi sportivi ecc.) al controllo e gestione dei flussi di traffico di veicoli e persone (sbarre di accesso a parcheggi e a zone a traffico limitato; apertura di serrature, apertura tornelli di accesso ecc.)
 Evitano l'abuso e gli sprechi nell'utilizzo di apparecchiature, consentendo la razionalizzazione dei servizi e la realizzazione di ulteriori introiti
- 

Wide range of devices for supplying of services subject to charges.
 Huge variety of applications: timing of many types of appliances (hair dryers, showers, washing machines, Jacuzzi, sports lighting, etc.); controlling and managing vehicles / people traffic (parking areas bars; opening of locks, turnstiles etc.)
 Preventing abuse and waste in the use of equipment, allowing the rationalization of services and the creation of additional revenue
- 

Gamme complète de dispositifs pour fournir des services payants.
 Grande variété d'applications: pour la synchronisation de nombreux types d'appareils (sèche-cheveux, douches, machines à laver et sèche, bain à remous, d'éclairage des terrains de sport, etc.), pour contrôler et gérer la circulation des véhicules et des personnes (les bars et les accès aux aires de stationnement, l'ouverture des écluses, tourniquets d'accès, etc.)
 Prévenir l'abus et le gaspillage dans l'utilisation des équipements, permettant la rationalisation des services et la création de revenus supplémentaires

GETTONIERE SINGOLE / SINGLE COIN UNIT / SYSTEME DE PAIEMENT



- 

FUNZIONAMENTO: moneta (20 o 50 centesimi o 1 o 2 Euro)
o a gettone (una unica scelta possibile)
- 

OPERATION: money (20 or 50 cents, or 1 or 2 euro) or token (only one choice)
- 

FONCTIONNEMENT: monnaie (20 ou 50 cents, ou 1 ou 2 euros)
ou jeton (un seul choix)

GET/1



UTILIZZALA CON
USE IT WITH
UTILISEZ AVEC





UNIK HAIR

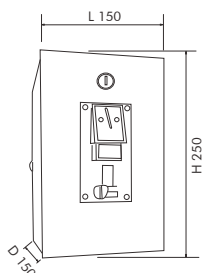

ACEA GET



- 

La gettoniera prevede esclusivamente un contatto pulito di 150 millisecondi al passaggio della moneta / gettone.
- 

The coin unit provides only a clean contact of 150 milliseconds to passage of coin / token.
- 

Le système de paiement fournit uniquement un contact propre de 150 millisecondes au passage de la pièce / jeton.



Peso: 3,0 kg. - Weight: 3,0 kg. - Poids: 3,0 kg.



GETTONIERE - COIN SYSTEMS - MONNAYEURS

COMUNITÀ / COMMUNITIES / COLLECTIVITÀ

GET/REG

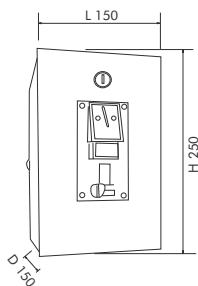

**UTILIZZALA CON
USE IT WITH
UTILISEZ AVEC**

- Gettoniera idonea per collegamento con qualsiasi tipo di apparecchiatura da temporizzare. Timer regolabile da 1 secondo a 300 ore.
- Coin unit suitable for timing of wide range of equipment. Adjustable timer from 1 second to 300 hours.
- Le système de paiement approprié pour la connexion de nombreux types d'appareils. Temporisateur réglable de 1 seconde à 300 heures.



ACEA GET



UNIK HAIR SPECIAL

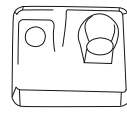

ARIEL HAIR

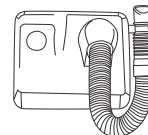

ARIEL HAIR TUBO



TURBO SPECIAL



Peso: 3,20 kg. - Weight: 3,20 kg. - Poids: 3,20 kg.

GET/DOCCIA

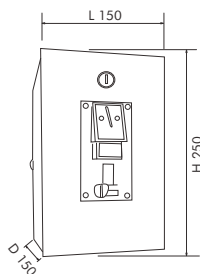

- Gettoniera per doccia con timer regolabile da 1 secondo a 300 ore. Elettrovalvola da 1/2 pollice e alimentatore 12 V inclusi.
- Coin unit suitable for showers of wide range of equipment, timer 1 sec - 300 h.
- Le système de paiement approprié pour douche, avec alimentateur 12 Vac et électrovalve. Temporisateur réglable de 1 seconde à 300 heures.



Peso: 3,80 kg. - Weight: 3,80 kg. - Poids: 3,80 kg.

GET/ILL

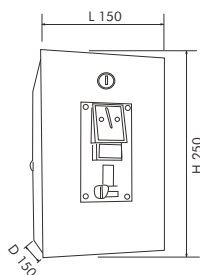

- Gettoniera adatta all'illuminazione di campi sportivi, con doppio timer regolabile fino a 12 ore, funzionante solo a gettone. Predisposta per segnale acustico o luminoso prima della scadenza del tempo.
- Coin unit with double timer adjustable up to 12 h, suitable for using in public lighting as football, tennis, or any else. It's possible to connect an acoustic or lighting advice before time finishing.
- Le système de paiement approprié pour l'éclairage de les terrains de sport, avec double temporisateur réglable jusqu'à 12 h. Possibilité de connexion au signal acoustique ou lumineux avant la fin du temps.



Peso: 3,50 kg. - Weight: 3,50 kg. - Poids: 3,50 kg.

CARATTERISTICHE GENERALI GENERAL FEATURES CARACTÉRISTIQUES GÉNÉRALES	Materiale centralina	Lamiera d'acciaio zincato bianco	GET/REG	Tensione di alimentazione	
	Box material	Steel, zinc plated, white colour		Supply Voltage	220 V-240 V
	Matériel de la boîte	Acier, plaqué zinc, blanc		Tension d'alimentation	
	Chiusura coperchio	Con serratura a chiave		Uscita	
	Closing	Lockable		Exiting	220 V-240 V
	Fermeture	Avec clé		Sortie	
Frequenza		Portata massima			
Frequency	50-60 Hz	Max capacity	1000 W		
Fréquence		Débit maximum			
Grado di protezione elettrica					
Electrical Protection Level	CLASS I				
Isolation électrique					
GET/1	Tensione di alimentazione	Non prevista	GET/DOCCIA GET/ILL	Tensione di alimentazione	
	Supply Voltage	...		Supply Voltage	12 V
	Tension d'alimentation	...		Tension d'alimentation	
	Uscita	Contatto pulito su faston maschio		Uscita	
	Exiting	Clean contact		Exiting	12 V
	Sortie	Contact propre		Sortie	
Portata massima	Non prevista	Portata massima			
Max capacity	...	Max capacity	100 W		
Débit maximum	...	Débit maximum			

GETTONIERE - COIN SYSTEMS - MONNAYEURS

COMUNITÀ / COMMUNITIES / COLLECTIVITÉ

GET/VETRORESINA



- 🇮🇹 Cassetta idonea all'utilizzo in ambienti esterni (classe I).
Modalità di funzionamento possibile come modelli:
 - GET/1/VETRORESINA
 - GET/REG/VETRORESINA
 - GET/DOCCIA/VETRORESINA

- 🇬🇧 Coin unit suitable for outdoor use (class I).
Operation as following models:
 - GET/1/FIBERGLASS
 - GET/REG/FIBERGLASS
 - GET/DOCCIA/FIBERGLASS

- 🇫🇷 Le système de paiement adapté pour une utilisation en extérieur (class I).
Mode de fonctionnement:
 - GET/1/FIBRE DE VERRE
 - GET/REG/FIBRE DE VERRE
 - GET/DOCCIA/FIBRE DE VERRE

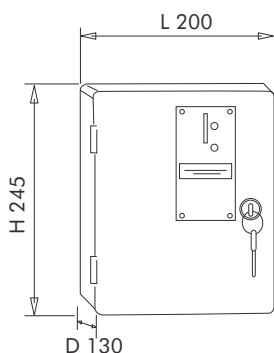

Materiale centralina	Vetroresina, colore bianco
Box material	Fiberglass, white colour
Matériel de la boîte	Fibre de verre, blanc
Chiusura coperchio	Con serratura a chiave
Closing	Lockable
Fermeture	Avec clé



ASPIRATORI - EXHAUST FANS - ASPIRATEURS



ASM 100

- 🇮🇹 Aspiratore da muro 12 W, portata 90 m³/h
 - 🇬🇧 Exhaust fan 12 W, 90 m³/h
 - 🇫🇷 Aspirateur murale 12 W, 90 m³/h
- Dimensioni/Dimensions/Dimensions: 160 x 150 x 120 mm*
Peso/Weight/Poids 0,8 kg

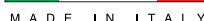
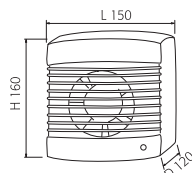

ASM 120

- 🇮🇹 Aspiratore da muro 20W, portata 165 m³/h
 - 🇬🇧 Exhaust fan 20 W, 165 m³/h
 - 🇫🇷 Aspirateur murale 20 W, 165 m³/h
- Dimensioni/Dimensions/Dimensions: 190 x 170 x 120 mm*
Peso/Weight/Poids 1,0 kg



ASM 100 ULTRAPIATTO

- 🇮🇹 Aspiratore ultrapiatto in plastica, colore bianco, portata 85 m³/h, 15 W
 - 🇬🇧 Ultra-flat plastic vacuum cleaner, white color, flow rate 85 m³/h, 15 W
 - 🇫🇷 Aspirateur en plastique ultra plat, couleur blanche, débit 85 m³/h, 15 W
- Dimensioni/Dimensions/Dimensions: 147 x 137 x 94 mm*
Peso/Weight/Poids 0,5 kg





LINEA IGIENE

Washroom Equipments - Équipements Sanitaires



LINEA INOX

ROLL INOX 200 MT.**ROLL INOX SATINATO 200 MT.**

- 🇮🇹 Distributore di carta igienica in rotolo (200 mt), acciaio inox AISI 430, con finitura brillante o satinata, Ø max rotolo 270 mm, Ø anima 40 mm
- 🇬🇧 Mini jumbo toilet roll dispenser (200 mt), AISI 430 stainless steel, with polished or brushed finish Ø max toilet paper roll 270 mm, Ø anima 40 mm
- 🇫🇷 Distributeur de papier toilette en rouleau (200 mt), en acier inoxydable AISI 430, finition brillante ou brossé, Ø max rouleau 270 mm, noyau Ø 40 mm.

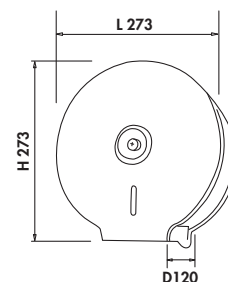
**ROLL INOX 400 MT.****ROLL INOX SATINATO 400 MT.**

- 🇮🇹 Distributore di carta igienica in rotolo (400 mt), acciaio inox AISI 430, con finitura brillante o satinata, Ø max rotolo 300 mm, Ø anima 40 mm
- 🇬🇧 Mini jumbo toilet roll dispenser (400 mt), AISI 430 stainless steel, with polished or brushed finish Ø max toilet paper roll 300 mm, Ø anima 40 mm
- 🇫🇷 Distributeur de papier toilette en rouleau (400 mt), en acier inoxydable AISI 430, finition brillante ou brossé, Ø max rouleau 300 mm, noyau Ø 40 mm.

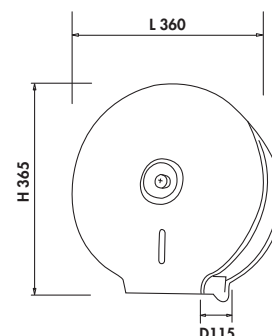
**MAXI INOX 400 FOGLI / SHEETS / FEUILLES**

- 🇮🇹 Distributore di carta asciugamani (400 fogli), per carta piegata a "C" o "Z". Acciaio inox AISI 430, con finitura brillante o satinata
- 🇬🇧 Hand towel dispenser (400 sheets), it holds "C" or "Z" fold paper towel. AISI 430 stainless steel, with polished or brushed finish
- 🇫🇷 Distributeur de papier essuie-mains (400 feuilles), pour papier plié en "C" ou "Z". Acier inoxydable AISI 430, finition brillante ou brossé.

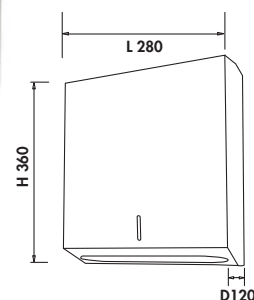
**MAXI INOX 500 FOGLI / SHEETS / FEUILLES**

- 🇮🇹 Distributore di carta asciugamani (500 fogli), per carta piegata a "C", "Z" o "V". Acciaio inox AISI 304, con finitura brillante
- 🇬🇧 Hand towel dispenser (500 sheets), it holds "C", "Z" or "V" paper towel. AISI 304 stainless steel, with polished finish
- 🇫🇷 Distributeur de papier essuie-mains (500 feuilles), pour papier plié en "C", "Z" ou "V". Acier inoxydable AISI 304, finition brillante.

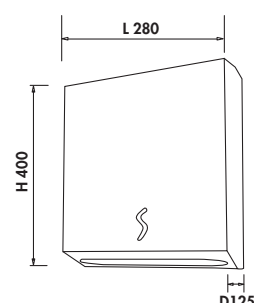

LINEA INOX



**C-FOLD
C-FOLD SATINATO**

- Distributore di carta igienica interfogliata in acciaio AISI 430, con finitura brillante o satinata. Capienza 500 fogli
- Interfolded toilet tissue dispenser. AISI 430 brushed or polished stainless steel. Capacity 500 sheets.
- Distributeur de papier toilette interplié en acier AISI 430, finition brillante ou brossé. Capacité 500 feuilles.

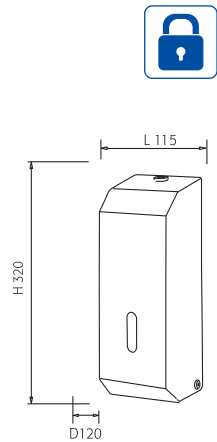

**DISA/Q
DISA/Q SATIN**

- Distributore di sapone liquido in acciaio inox AISI 304, con finitura brillante o satinata. Serbatoio fuso nella struttura, capienza 1,2 lt.
- Liquid soap dispenser. AISI 304 polished or brushed stainless steel. Refillable tank 1,2 lt.
- Distributeur de savon liquide en acier inoxydable AISI 304, finition brillante ou brossé. Capacité 1,2 lt.

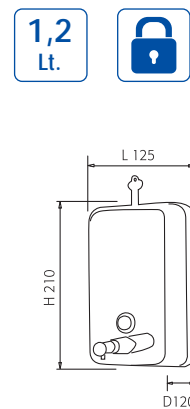

SISTEMA PUSH – PUSH SYSTEM

- Per tutti i tipi di sapone salvo a microgranuli
- Accepts all kinds of soap except the microgranules
- Pour tous les types de savon sauf les microgranules



DISA L NEW

- Distributore di sapone liquido in acciaio inox AISI 304, con finitura brillante. Serbatoio fuso nella struttura, capienza 0,5 lt.
- Liquid soap dispenser. AISI 304 polished stainless steel. Refillable plastic tank 0,5 lt.
- Distributeur de savon liquide en acier inoxydable AISI 304, finition brillante. Capacité 0,5 LT.

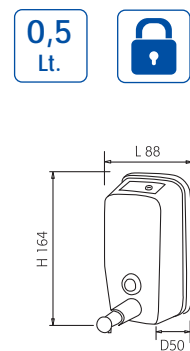

SISTEMA PUSH – PUSH SYSTEM

- Per tutti i tipi di sapone salvo a microgranuli
- Accepts all kinds of soap except the microgranules
- Pour tous les types de savon sauf les microgranules



**DISA/PULL
DISA/PULL SATIN**

- Distributore di sapone liquido in acciaio inox AISI 304, con finitura brillante o satinata. Tanica in plastica a riempimento, da 1,2 lt.
- Liquid soap dispenser. AISI 304 polished or brushed stainless steel. Refillable plastic tank 1,2 lt.
- Distributeur de savon liquide en acier inoxydable AISI 304, finition brillante ou brossé. Réservoir de remplissage en plastique, 1,2 lt.

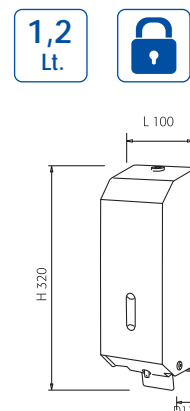

SISTEMA PULL – PULL SYSTEM

- Per tutti i tipi di sapone salvo a microgranuli
- Accepts all kinds of soap except the microgranules
- Pour tous les types de savon sauf les microgranules



**DISIGIENICO
DISIGIENICO SATIN**

- 🇮🇹 Distributore di sacchetti igienici in carta. Acciaio inox AISI 304, brillante o satinato
- 🇬🇧 Sanitary towel bag dispenser. AISI 304 stainless steel, with polished or brushed finish
- 🇫🇷 Distributeur de sacs en papier hygiénique. Acier inoxydable AISI 304, brillant ou brossé.

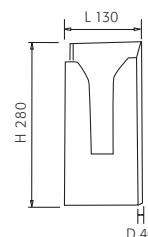

**AISI
304**

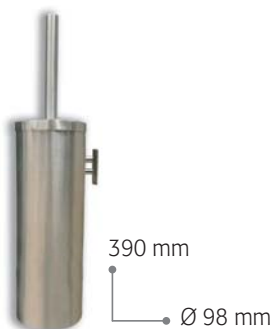

🇮🇹 **PORTASCOPINO MURALE PLUS**

- Acciaio AISI 304 brillante o satinato
- Fissaggio murale in 3 punti
- Bacinella di recupero in plastica
- Viteria inclusa

🇬🇧 **TOILET BRUSH WALL MOUNTED PLUS**

- Stainless steel AISI 304, polished or brushed finish
- Wall mounting support in 3 points
- Plastic inner bucket to ensure tightness and facilitate cleaning
- Screws included

🇫🇷 **PORTE-BALAIS WC MURAL PLUS**

- Acier AISI 304, brillant ou satiné
- Le montage mural en 3 points
- Bac de récupération en plastique
- Vis incluses

3 lt

5 lt

12 lt



3 lt

5 lt

12 lt



HACCP

🇮🇹 **PATTUMIERE A PEDALE INOX 3/5/12 lt.**

- Acciaio inox 403, con base in ABS
- Maniglia per facilitare lo svuotamento
- Secchio interno in plastica
- Maniglia di trasporto in metallo

🇬🇧 **INOX PEDAL BINS 3/5/12 lt.**

- 403 Stainless Steel, with ABS base
- Metal handle for easy access
- Plastic inside bucket with metal handle
- Steel metal back handle

🇫🇷 **POUBELLE EN ACIER A PÉDALE 3/5/12 lt.**

- En acier inoxydable 403 avec base en ABS
- Poignée pour faciliter la vidange
- Seau en plastique avec poignée intérieure
- Poignée de transport en métal

25 lt



500 mm
200 mm
300 mm

GETTACARTE INOX LUCIDO / SATINATO

- Acciaio inox 403 brillante o satinato -
- Fissaggio murale o d'appoggio
- Viteria non inclusa
- Misure fissaggio (L x H) 20 x 43 cm

INOX WASTE BIN

- 403 Stainless steel, with polished or brushed finished
- Freestanding or wall mount fastening
- Fixing hardware not included
- Fixing measures (L x H) 20 x 43 cm

PEUBELLE MURALE INOX

- Acier inoxydable 403 brillant ou satiné
- Fixation au mur ou au sol
- Vis non incluses
- Mesures de fixation (L x H) 20 x 43 cm



MADE IN ITALY



MANIGLIONI MURALI

Acciaio Inox AISI 304 (18/10) brillante
 Ø del tubo: 32 mm
 Spessore: 1 mm

WALL-MOUNTED GRAB BARS

Shining Stainless Steel AISI 304 (18/10)
 External Tube Ø: 32 mm
 Thickness: 1 mm

BARRES D'APPUI INOX

Acier inox AISI 304 brillant
 External Tube Ø: 32 mm
 Épaisseur: 1 mm

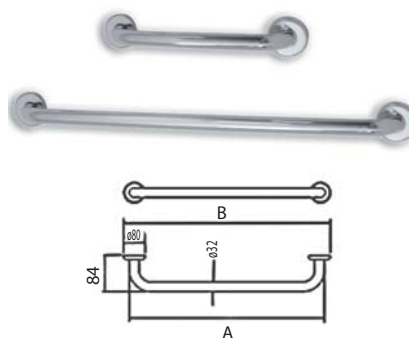

Cod.	Lunghezza/Lenght A	Lunghezza/Lenght B
105301	480 mm	530 mm
105304	840 mm	890 mm

MANIGLIONE MURALE RECLINABILE A PARETE

Acciaio Inox AISI 304 (18/10)
 Spessore della placca: 5 mm
 Ø del tubo: 32 mm
 Spessore tubo: 1,2 mm
 Fissaggio murale in 4 punti (viti di fissaggio incluse)

WALL-MOUNTED SWING HAND RAIL

Shining Stainless Steel AISI 304 (18/10)
 Fixing plate: 5 mm thickness
 External Tube Ø: 32 mm
 Thickness: 1,2 mm
 4 points fixing (Stainless steel screws included)

BARRE D'APPUI FLESSIBILE MURALE

Acier inox AISI 304 brillant
 Plaque de fixation: 5 mm d'épaisseur
 External Tube Ø: 32 mm
 Épaisseur: 1,2 mm
 Montage mural en 4 points (vis en acier inoxydable inclus)



Cod.	Descrizione
105305	Inox AISI 304 / Stainless Steel AISI 304

MANIGLIONE PIEGATO MURALE CON PORTA SAPONE

Acciaio Inox AISI 304 (18/10)
 Ø del tubo: 25 mm
 Angolo di piega: 135°
 Destro e sinistro

CURVED GRAB BAR WITH SOAP HOLDER

Shining Stainless Steel AISI 304 (18/10)
 External Tube Ø: 25 mm
 Angle of bending: 135°
 Can be used on left or right side

POIGNÉE INOX AVEC PORTE SAVON

Acier inox AISI 304 brillant
 External Tube Ø: 25 mm
 Angle de cintrage: 135°
 Droite et gauche



Cod.	Descrizione
105306	Inox AISI 304 / Stainless Steel AISI 304

LINEA ABS



ROLL ABS 400 MT. BASIC



- Distributore di carta igienica in rotolo, base in ABS grigio e cover in ABS bianco. Mandrino Ø 45 e 70 mm per rotolo da 400 m. (Ø max rotolo 300 mm.)
- Toilet paper roll dispenser, grey ABS backing and white ABS cover. Spindle Ø 45 and 70 mm for 400 m paper roll. (Ø roll max 300 mm)
- Distributeur de papier toilette en rouleau, base en ABS gris et couvercle en ABS blanc. Mandrin Ø 45 et 70 mm pour rouleau 400 mt. (Ø max rouleau 300 mm)

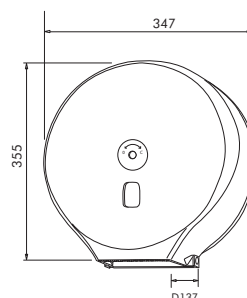

ROLL ABS 200 MT. BASIC



- Distributore di carta igienica in rotolo, base in ABS grigio e cover in ABS bianco. Mandrino Ø 45 mm per rotolo da 200 m. (Ø max rotolo 255 mm.)
- Toilet paper roll dispenser, grey ABS backing and white ABS cover. Spindle Ø 45 for 200 m paper roll. (Ø roll max 255 mm)
- Distributeur de papier toilette en rouleau, base en ABS gris et couvercle en ABS blanc. Mandrin Ø 45 mm pour rouleau 200 mt. (Ø max rouleau 255 mm)

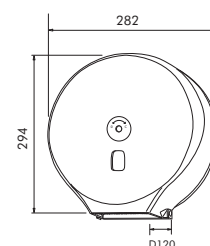

MAXI 400 FOGLI / SHEETS / FEUILLES



- Distributore di carta asciugamani, base in ABS grigio e cover in ABS bianco. Carta piegata a C, Z o M. Capienza 400 fogli.
- Hand towel dispenser, grey ABS backing and white ABS cover. It holds C, Z or M fold paper towel. Capacity 400 sheets.
- Distributeur de papier essuie-mains, base en ABS gris et couvercle en ABS blanc. Papier plié en "C", "Z" ou "M". Capacité 400 feuilles.

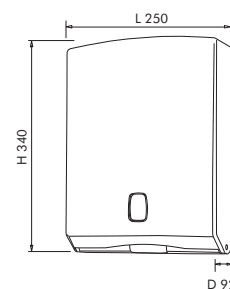

MINI 200 FOGLI / SHEETS / FEUILLES



- Distributore di carta asciugamani, base in ABS grigio e cover in ABS bianco. Carta piegata a C, Z o M. Capienza 200 fogli.
- Hand towel dispenser, grey ABS backing and white ABS cover. It holds C, Z or M fold paper towel. Capacity 200 sheets.
- Distributeur de papier essuie-mains, base en ABS gris et couvercle en ABS blanc. Papier plié en "C", "Z" ou "M". Capacité 200 feuilles.

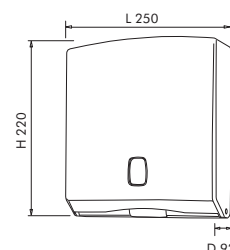

LINEA ABS

**DISA P/1000 TU**1,0
Lt.

- Distributore di sapone liquido, base in ABS grigio e cover in ABS bianco. Tanica in plastica a riempimento da 1 lt. con tappo
- Liquid soap dispenser, grey ABS backing and white ABS cover. Refillable plastic tank 1 lt.
- Distributeur de savon liquide, base en ABS gris et couvercle en ABS blanc. Réservoir en plastique à remplissage 1 lt. avec bouchon.

222 mm
135 mm
155 mm**SISTEMA PUSH – PUSH SYSTEM**

- Per tutti i tipi di sapone salvo a microgranuli
- Accepts all kinds of soap except the microgranules
- Pour tous les types de savon sauf les microgranules

**DISA P/500 TU**0,5
Lt.

- Distributore di sapone liquido, base in ABS grigio e cover in ABS bianco. Tanica in plastica a riempimento da 0,5 lt. con tappo
- Liquid soap dispenser, grey ABS backing and white ABS cover. Refillable plastic tank 0,5 lt.
- Distributeur de savon liquide, base en ABS gris et couvercle en ABS blanc. Réservoir en plastique à remplissage 0,5 lt. avec bouchon.

175 mm
125 mm
102 mm**SISTEMA PUSH – PUSH SYSTEM**

- Per tutti i tipi di sapone salvo a microgranuli
- Accepts all kinds of soap except the microgranules
- Pour tous les types de savon sauf les microgranules

**PORTASOPINO MURALE**

Portascopino murale o d'appoggio in polipropilene bianco

WALL MOUNTING TOILET BRUSH

Freestanding or wall mounted toilet brush holder in white polypropylene

PORTE-BALAIS MURAL

Porte-balais mural ou à poser en polypropylène blanc

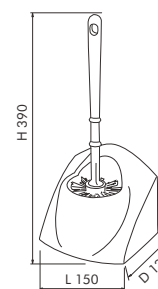

H 390

L 150

D 130

**DISIGIENICO ABS**

- Distributore di sacchetti igienici in carta in ABS bianco
- Paper sanitary towel bag dispensers, white ABS
- Distributeur de sacs en papier hygiénique, en ABS blanc.

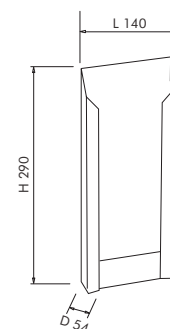

H 290

L 140

D 54

DISPENSER GEL IGIENIZZANTE

SANITIZING GEL DISPENSER - DISTRIBUTEUR DE GEL DÉINFECTANT



MATIC - SOAP

🇮🇹 Distributore automatico di sapone liquido / gel igienizzante, capienza 600 ml

🇬🇧 Automatic dispenser of liquid soap / sanitizing gel, capacity up to 600 ml.

🇫🇷 Distributeur automatique de savon liquide / gel désinfectant, capacité 600 ml.

600 ml.



REGOLABILE - ADJUSTABLE - RÉGLABLE

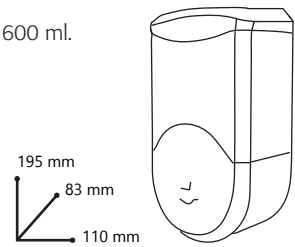

AUTO - SOAP

🇮🇹 Distributore automatico di sapone liquido / gel igienizzante, capienza 600 ml.

🇬🇧 Automatic dispenser of liquid soap / sanitizing gel, capacity up to 600 ml.

🇫🇷 Distributeur automatique de savon liquide / gel désinfectant, capacité 600 ml.

600 ml.

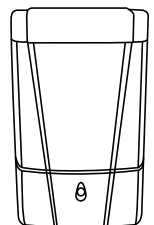
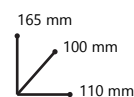

PIANTANA MOBILE MATIC - SOAP

PIANTANA MOBILE AUTO - SOAP



🇮🇹 Piantana mobile per dispenser automatici

🇬🇧 Mobile stand for automatic dispenser

🇫🇷 Support mobile pour distributeurs automatiques

MADE IN ITALY



Abbinabile con



SUPPORTO MURALE MATIC - SOAP

SUPPORTO MURALE AUTO - SOAP



🇮🇹 Supporto murale per dispenser automatici

🇬🇧 Wall-mounted automatic dispenser holder

🇫🇷 Support mural pour distributeurs automatiques

MADE IN ITALY

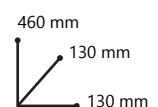

LINEA ANTI-COVID



SMART - SOAP

- Distributore automatico di sapone liquido / gel igienizzante da appoggio, capienza 310 ml.
- Automatic countertop dispenser of liquid soap / sanitizing gel, capacity up to 310 ml.
- Distributeur automatique sur comptoir de savon liquide / gel désinfectant, capacité 310 ml.

SISTEMA AUTOMATICO – AUTOMATIC SYSTEM



PIANTANA SMART-SOAP



- Piantana mobile per dispenser automatico
- Mobile stand for hand automatic dispenser
- Support mobile pour distributeurs automatiques

Abbinabile con

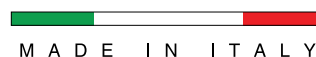
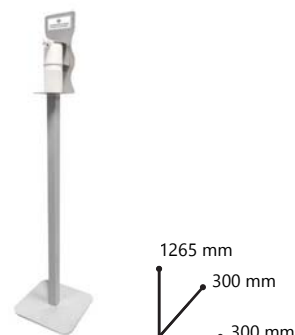

MADE IN ITALY

SUPPORTO D'APPOGGIO

SUPPORTO MURALE



- Supporto in acciaio con duplice funzione d'appoggio (antitaccheggio) o fissaggio murale
- Grey steel automatic dispenser holder, with dual function: anti-theft holder or wall mounting holder
- Support en acier à double fonction support (antivol) ou fixation murale

Abbinabile con



MADE IN ITALY

TERMOMETRO DIGITALE



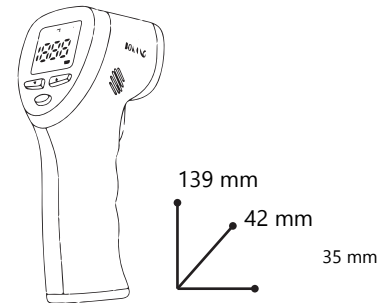
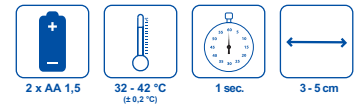

**DISPOSITIVO MEDICO
CERTIFICATO IN BASE ALLA
NORMA 93/42/EU**

ISO 13485  CE 0197



 Termometro digitale senza contatto.

 Infrared thermometer. Contactless

 Thermomètre numérique sans contact





 **DISPLAY RETROILLUMINATO CON
INDICAZIONE BATTERIA E TEMPERATURA**

 **BACKLIT DISPLAY, TEMPERATURE
AND BATTERY LEVEL**

 **AFFICHAGE RÉTROÉCLAIRÉ, TEMPÉRATURE
ET NIVEAU DE LA BATTERIE**

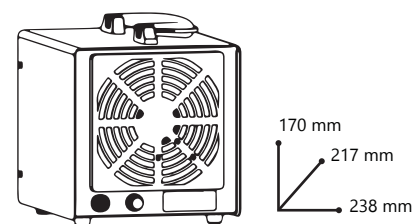
OZONIZZATORE



 Generatore di ozono portatile da 15 g/h, assorbimento 120 W. Efficace per ambienti fino a 100 m³/q contro agenti inquinanti, acari della polvere, muffe, batteri e virus dotati di membrana protettiva.

 Portable ozone generator, 15 g/h, 120 W absorption. Suitable for use in large space up to 100 m³/q. Effective against pollutants, dust mites, molds, bacteria and viruses with a protective membrane.

 Générateur d'ozone portable 15 g/h, absorption 120 W. Efficace pour les environnements jusqu'à 100 m³/q contre les polluants, les acariens, les moisissures, les bactéries et les virus avec une membrane protectrice.





VAMA[®]
Revolution-air hand dryer 

Via Damiano Chiesa, 37
20026 Novate Milanese (MI) - Italy
Tel. +39 02 59903050 • Fax +39 02 59903067
www.vama.it • info@vama.it

 [vama_handdryers](https://www.instagram.com/vama_handdryers)

 [VAMA Asciugamani
elettrici](https://www.facebook.com/VAMAAsciugamaniElettrici)

