





VELOCITÀ ASCIUGATURA
DRYING TIME / TEMPS DE SÉCHAGE



RISPARMIO ENERGETICO
ENERGY SAVING / ÉPARGNE ENERGETIQUE



SILENZIOSITÀ
NOISELESS / SILENCIEUX



DESIGN



ANTIVANDALISMO
ANTIVANDALISM / ANTIVANDALISME



EcoSTREAM EcoFlow

ECO-JET DRYERS

ASCIUGAMANI - HAND DRYERS - SÈCHE-MAINS



- 
- 67 VOLTE PIU' ECONOMICO
 RISPETTO AI ROTOLI DI COTONE
- 52 VOLTE PIU' ECONOMICO**
 RISPETTO ALLA CARTA
- 7 VOLTE PIU' ECONOMICO**
 RISPETTO AGLI ASCIUGAMANI TRADIZIONALI
- 
- 67 TIMES BETTER
 THAN COTTON DISPENSING RENT SERVICES
- 52 TIMES BETTER**
 THAN PAPER
- 7 TIMES BETTER**
 THAN TRADITIONAL HAND DRYERS
- 
- 67 FOIS MIEUX
 QUE LE COTON
- 52 FOIS MIEUX**
 QUE LE PAPIER
- 7 FOIS PLUS EFFICACE**
 QUE LE SÈCHE-MAINS ÉLECTRIQUE TRADITIONNEL



GARANZIA 3 ANNI • WARRANTY 3 YEARS • GARANTIE 3 ANS

 MADE
IN ITALY

CE



WEEE



GUIDA ALLA SCELTA / HOW TO CHOOSE / COMMENT CHOISIR

1

🇮🇹 SCEGLI: CONO D'ARIA (ECOstream) o LAMA D'ARIA (ECOflow)?



🇬🇧 CHOOSE: HOLE (ECOstream) OR BLADE (ECOflow)?

🇫🇷 SELECTIONNER: CONE D'AIR (ECOstream) OU LAME D'AIR (ECOflow)?

2

🇮🇹 SCEGLI IL MODELLO

🇬🇧 CHOOSE THE MODEL

🇫🇷 CHOISISSEZ LE MODÈLE



550 W

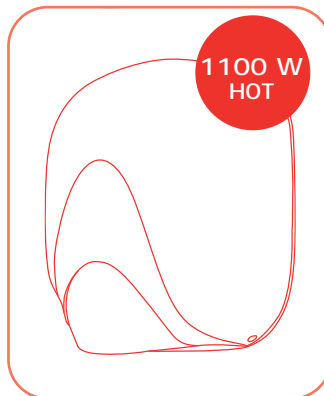

1100 W
HOT

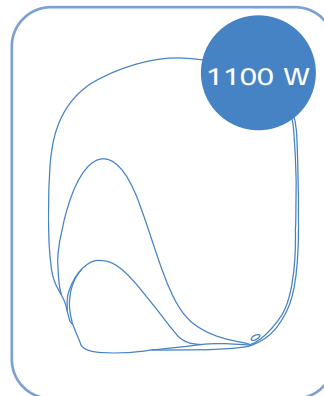

1100 W

🇮🇹 ECOLOGICO: IL MAGGIOR RISPARMIO ENERGETICO

🇬🇧 ECO FRIENDLY: ENERGY EFFICIENT

🇫🇷 ECOLOGIQUE: ECONOMIE D'ÉNERGIE ABSOLUE

ARIA CALDA IMMEDIATA!
MOTORE 550 W +
RESISTENZA 550 W

IMMEDIATELY HOT AIR!
550 W MOTOR +
550 W HEATING ELEMENT

AIR CHAUD IMMÉDIATEMENT!
550 W MOTEUR +
550 W CHAUFFAGE

POTENZA ASSOLUTA:
IL PIÙ VELOCE

POWERFUL:
THE FASTEST ONE

PUISSANT:
LE PLUS RAPIDE

3

🇮🇹 SCEGLI LA COVER

🇬🇧 CHOOSE YOUR FAVOURITE COVER

🇫🇷 CHOISISSEZ VOTRE COUVERTURE FAVORITE



ABS bianco, automatico
white ABS, sensor operating
ABS blanc, capteur



alluminio bianco, automatico
white metal, sensor operating
metal blanc, capteur



alluminio satinato, automatico
satin metal, sensor operating
metal satin, capteur



alluminio cromato, automatico
chrome metal, sensor operating
metal chromé, capteur



550 W - 1100 W

TEMPO DI ASCIUGATURA: 10 - 15 sec - VELOCITA' ARIA 325 km/h (versione 1100 W)

IGIENE INTEGRATA

Il filtro EPA E11 (opzione) garantisce protezione contro oltre il 97,66 % dei batteri presenti nell'aria che viene utilizzata durante l'asciugatura.

RISPARMIO ENERGETICO ASSOLUTO: SOLO 2,3 W PER ASCIUGATURA (versione 550 W)

- oltre 52 volte più economico rispetto alla carta (550 W)
- 85 % - 90 % di risparmio rispetto ai modelli di asciugamani tradizionali

MOTORE STANDARD AC ALTA PRESSIONE

ASSENZA DI RESISTENZA ELETTRICA: riscaldamento dell'aria per compressione ed attraverso il calore dei motori, abbattendo i consumi e minimizzando i costi manutenzione.

DRYING TIME: 10 - 15 sec - AIR SPEED 325 km /h (1100 W version)

INTEGRATED HYGIENIC SYSTEM

EPA E11 filter (option) allows protection against 97,66 % of air bacteria, spreading clean air on hands.

ECOLOGICAL HAND DRYER, THE LOWEST POWER CONSUMPTION: ONLY 2,3 W per drying cycle (550 W version)

- SAVE 52 times than paper (550 W)
- SAVE 85 % - 90 % than traditional hand dryers

AC STANDARD MOTOR HIGH PRESSURE

NO HEATING ELEMENT: air heating through compression and engines warming, reducing energy consumption and minimizing maintenance costs.

TEMPS DE SÈCHAGE: 10 - 15 sec - VITESSE D'AIR 325 kilomètres par heure (Version 1100 W)

HYGIÈNE INTÉGRÉE

Le filtre EPA E11 (en option) offrant une protection de plus 99,997 % des bactéries aéroportées qui est utilisée pendant le séchage.

ÉCONOMIE D'ÉNERGIE ABSOLUE: SEULEMENT 2,3 WATT POUR LE SÈCHAGE (Version 550 W)

- Plus de 52 fois d'économie par rapport au papier (550 W)
- 85 % - 90 % d'économie par rapport aux modèles traditionnels de sèche-mains

STANDARD MOTEUR AC HAUTE PRESSION

ABSENCE DE RÉSISTANCE ÉLECTRIQUE: chauffage de l'air grâce à la compression et à la chaleur des moteurs, ce qui réduit la consommation d'énergie et les coûts de maintenance.

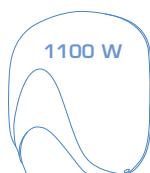

**NESSUNA RESISTENZA ELETTRICA:
RISCALDAMENTO PROGRESSIVO CON L'UTILIZZO**

**NO HEATING ELEMENT:
PROGRESSIVE AIR HEATING**

**ABSENCE DE RÉSISTANCE ÉLECTRIQUE:
CHAUFFAGE AIR PROGRESSIF**



1100 W HOT

MODELLI CON RESISTENZA ELETTRICA 550 W + MOTORE 550 W, TOT. 1100 W

Perfetto equilibrio tra velocità di asciugatura / risparmio energetico / rumorosità
Il comfort dell'aria calda fin dal primo utilizzo, con un risparmio energetico eccezionale

MODELS WITH 550 W MOTOR + 550 W HEATING ELEMENT, TOT. 1100 W

Perfect balance between drying speed / energy efficient use / noise
Immediately warm air for a more comfortable drying experience, with exceptional power saving

MODÈLES AVEC CHAUFFAGE ELECTRIQUE 550 W + MOTEUR 550 W, TOT. 1100 W

L'équilibre parfait entre vitesse de séchage / économie d'énergie / bruit
Le confort de l'air chaud à partir de la première utilisation, avec économie d'énergie exceptionnelle

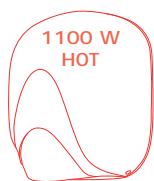

- ARIA CALDA IMMEDIATA!!!**
- IMMEDIATELY HOT AIR!!!**
- AIR CHAUD IMMEDIATEMENT!!!**



Il filtro EPA E11 (opzione) garantisce protezione contro il 97,66% dei batteri* presenti nell'aria che viene utilizzata durante l'asciugatura

EPA E11 filter (option) allows protection against 97,66% of bacteria, spreading clean air on hands*

Le filtre EPA E11 (en option) assure une protection de 97,66% contre les bactéries* contenues dans l'air au cours du séchage

* Certificato da ALTFILTER - Certificate from ALTFILTER - Certification ALTFILTER



COVER IN ALLUMINIO CON VERNICIATURA DI COLORE NERO METALLIZZATO, FINITURA GOFFRATA

DISPONIBILE PER TUTTE LE VERSIONI 550 - 1100 - 1100 HOT

METAL COVER, BLACK METALLIC PAINT, EMBOSSED FINISH

AVAILABLE FOR ALL VERSIONS 550 - 1100 - 1100 HOT



COVER EN METAL AVEC PEINTURE MÉTALLISÉE NOIRE, FINITION EN RELIEF

DISPONIBLE POUR TOUTES LES VERSIONS 550 - 1100 - 1100 HOT

EcoSTREAM EcoFlow

ECO-JET DRYERS

ASCIUGAMANI - HAND DRYERS - SÈCHE-MAINS

-  ARTICOLI & CODICI PRODOTTO
-  MODEL REFERENCE CHART
-  TABLEAU DES MODÈLE DE RÉFÉRENCE



Cod.	Mod.			Cod.	Mod.		
EST ABS 550	ECOstream	ABS Bianco / White / Blanc	550W	EFL ABS 550	ECOflow	ABS Bianco / White / Blanc	550W
EST ABS 1100	ECOstream	ABS Bianco / White / Blanc	1100W	EFL ABS 1100	ECOflow	ABS Bianco / White / Blanc	1100W
EST BF 550	ECOstream	Metallo Bianco White metal / Metal blanc	550W	EFL BF 550	ECOflow	Metallo Bianco White metal / Metal blanc	550W
EST BF 1100	ECOstream	Metallo Bianco White metal / Metal blanc	1100W	EFL BF 1100	ECOflow	Metallo Bianco White metal / Metal blanc	1100W
EST LF 550	ECOstream	Metallo Cromato Chrome metal / Metal chromé	550W	EFL LF 550	ECOflow	Metallo Cromato Chrome metal / Metal chromé	550W
EST LF 1100	ECOstream	Metallo Cromato Chrome metal / Metal chromé	1100W	EFL LF 1100	ECOflow	Metallo Cromato Chrome metal / Metal chromé	1100W
EST SF 550	ECOstream	Metallo Satinato Satin metal / Metal satin	550W	EFL SF 550	ECOflow	Metallo Satinato Satin metal / Metal satin	550W
EST SF 1100	ECOstream	Metallo Satinato Satin metal / Metal satin	1100W	EFL SF 1100	ECOflow	Metallo Satinato Satin metal / Metal satin	1100W
EST NF 550	ECOstream	Metallo Nero Black metal / Metal noir	550W	EST NF 550	ECOflow	Metallo Nero Black metal / Metal noir	550W
EST NF 1100	ECOstream	Metallo Nero Black metal / Metal noir	1100W	EST NF 1100	ECOflow	Metallo Nero Black metal / Metal noir	1100W



Cod.	Mod.			Cod.	Mod.		
EST ABS 1100 HOT	ECOstream	ABS Bianco / White / Blanc	1100W	EFL ABS 1100 HOT	ECOflow	ABS Bianco / White / Blanc	1100W
EST BF 1100 HOT	ECOstream	Metallo Bianco White metal / Metal blanc	1100W	EFL BF 1100 HOT	ECOflow	Metallo Bianco White metal / Metal blanc	1100W
EST LF 1100 HOT	ECOstream	Metallo Cromato Chrome metal / Metal chromé	1100W	EFL LF 1100 HOT	ECOflow	Metallo Cromato Chrome metal / Metal chromé	1100W
EST SF 1100 HOT	ECOstream	Metallo Satinato Satin metal / Metal satin	1100W	EFL SF 1100 HOT	ECOflow	Metallo Satinato Satin metal / Metal satin	1100W
EST NF 1100 HOT	ECOstream	Metallo Nero Black metal / Metal noir	1100W	EFL NF 1100 HOT	ECOflow	Metallo Nero Black metal / Metal noir	1100W



OPZIONE FILTRO EPA E11 (TUTTI I MODELLI)
EPA E11 FILTER OPTION (ALL MODELS)
FILTRE EPA E11 EN OPTION (TOUS LES MODÈLES)

- ❶ **CONFRONTO COSTI DI ASCIUGATURA ANNUALI**
- ❷ **ANNUAL SAVINGS CALCULATION**
- ❸ **CALCULEZ VOS COÛTS/ECONOMIES ANNUELLES**

N° UTILIZZI GIORNALIERI DAILY USE UTILISATION PAR JOUR	ECOSTREAM ECOFLOW 1100W	ECOSTREAM ECOFLOW 550W	VAMA TORNADO PROTECH®	COTONE COTTON COTON	CARTA PAPER PAPIER	ASCIUGAMANI TRADIZIONALI 2400 W TRADITIONAL HAND DRYERS 2400 W SÈCHE-MAINS STANDARD 2400 W
100	€ 22,05/anno	€ 13,89/anno	€ 30,04	€ 949,00	€ 730,00	€ 104,04
200	€ 44,10/anno	€ 27,79/anno	€ 58,55	€ 1.898,00	€ 1.460,00	€ 205,91
400	€ 88,19/anno	€ 55,57/anno	€ 115,52	€ 3.504,00	€ 2.920,00	€ 409,65



Calcoli basati su 100 / 200 / 400 utilizzi al giorno nonché sull'utilizzo di 1 unità. Costo dell'energia di € 0,1655/kWh; costo di € 0,01 per salvietta di carta, con una media di 2 salviette per asciugatura. I costi effettivi possono variare.



Based on 100 / 200 / 400 uses per day. Energy cost € 0,1655/kWh; paper cost € 0,01 per sheet, with use of two sheets at once.



Calculs basés sur 100 / 200 / 400 utilisations par jour et l'utilisation de 1 unité. Coût en énergie de € 0,1655 / kWh; coût de € 0,01 pour les serviettes en papier, avec une moyenne de 2 serviettes de toilette pour le séchage. Coûts réels peuvent varier.

CARATTERISTICHE TECNICHE / TECHNICAL FEATURES / CARACTÉRISTIQUES TECHNIQUES

Funzionamento	Sensore di rilevam. elettronico a raggi infrarossi	Volume aria	
Functioning	Sensor operating	Air Flow	187 m ³ /h - 52 l/s (1100 W), 126 m ³ /h - 35 l/s (550 W)
Activation	Capteur électronique	Débit d'air	
Ciri al minuto		Peso	
Tr min	30000 rpm (1100 W) - 26000 rpm (550 W)	Weight	5,00 Kg (Metallo) - 3,00 Kg (ABS)
Révolutions par minute		Poids net	
Grado di protezione elettrica		Materiale	ABS - Alluminio pressofuso
Electrical Protection Level	IP23 - CLASS II	Materials	ABS - Die Cast Aluminium
Isolation électrique		Matériel	ABS - en fonte d'aluminium
Tensione		Marchi di qualità	
Supply Voltage	220 V-240 V	Quality marks - certifications	CE
Tension d'alimentation		Certification	
Potenza totale		Rumorosità (2 mt)	
Total power	1100 W - 550 W	Noise Level (2 mt)	80 db (1100 W) 75 db (550 W)
Puissance totale		Niveau sonore (2 mt)	
Potenza resistenza		Garanzia	3 anni*
Absorption Heating Element	550 W (solo - only - seule mod. HOT)	Warranty	3 years*
Puissance chauffage		Garantie	3 ans*
Potenza motore			
Absorption Motor	1100 W - 550 W		
Puissance moteur			
Dimensioni A x L x P			
Dimensions H x W x D	285 X 221 X 157 mm		
Dimensions H x L x P			
Frequenza			
Frequency	50-60 Hz		
Fréquence			
Velocità aria			
Air Speed	325 km/h (1100 W) - 250 km/h (550 W)		
Vitesse d'air			

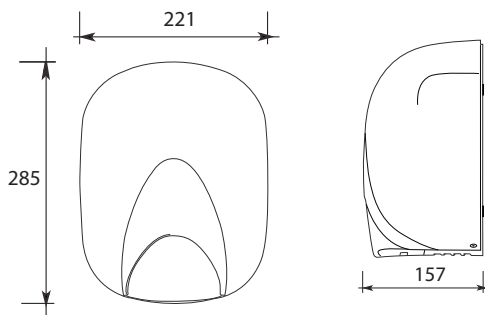

❶ * Per le limitazioni di garanzia si vedano le condizioni generali di servizio

❷ * Limited warranty. Please have a look to the General Warranty Conditions for details and consumables

❸ * Limitations de garantie: revoir Conditions de Garantie Generale